

## INOXLINE PROGRAMM

Stainless steel connection solutions

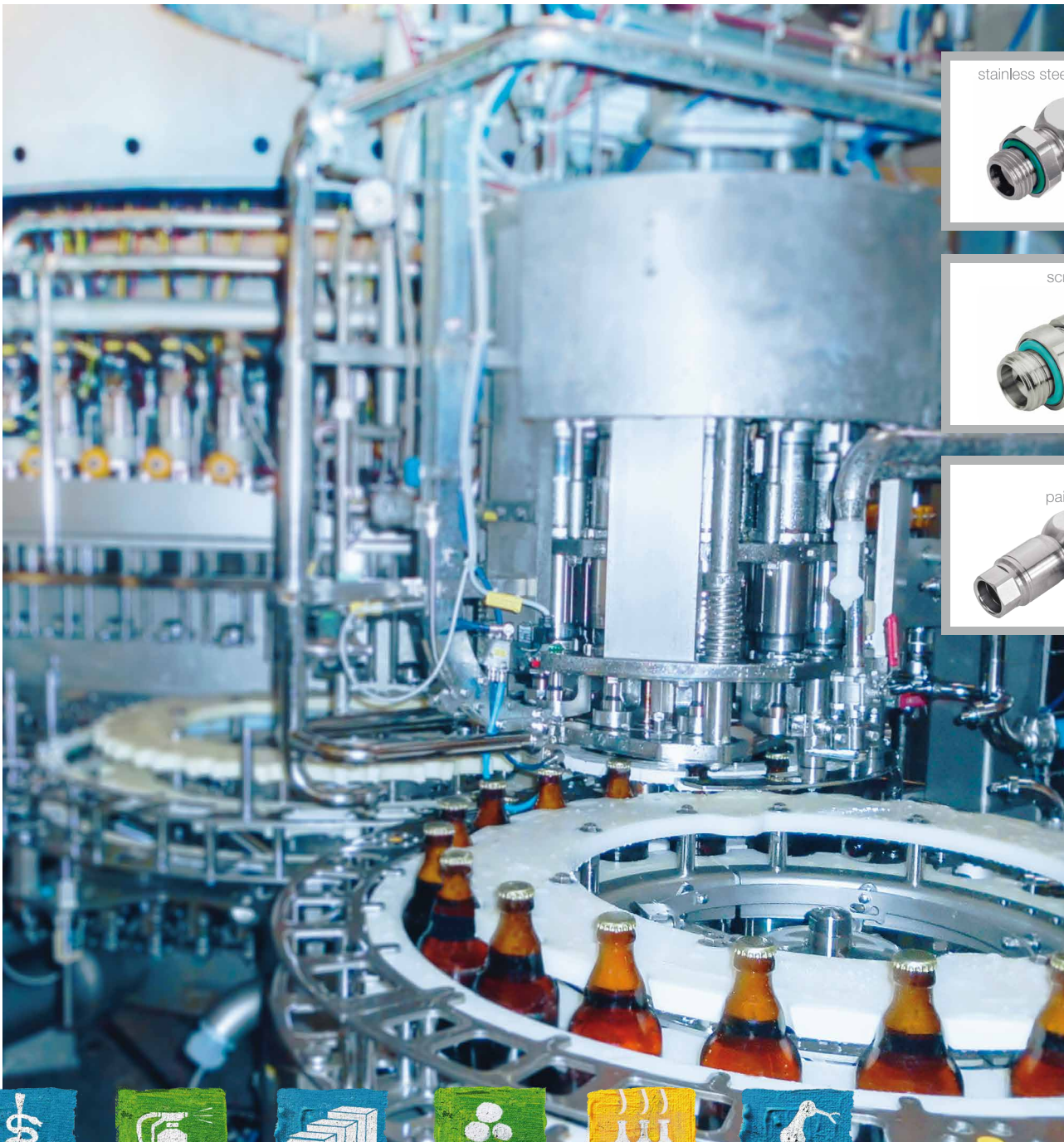

stainless steel plug connectors



screw-in connectors



connectors for painting applications



## EISELE IS QUALITY MADE IN GERMANY

Over 30 patents, more than 8,000 standard articles, and 2,000 customized solutions impressively underline our top quality performance. Whether the solution is configured from standard components or individually customized: all EISELE products boast convincing quality, long lifetimes and sophisticated technology.

Our company is loyal to its philosophy and its roots. Germany is the place where we find our highly qualified employees – the workforce responsible for our company's output. With a manufacturing depth of almost 100%, and stock being kept at the production site itself, we can optimally supply our customers, and respond quickly to fulfill needs and technical specifications. EISELE is part of a global logistics network that guarantees the fast availability of our products on the global market.

DIN EN ISO 9001: 2008 – EISELE has been certified since 1994. We have continuously been updating this quality standard and will continue to maintain it with future certifications. The elements of our basic philosophy include sustainable quality, flexibility and continuous improvement.









Since 2014 Eisele is certified regarding the international economic standard DIN EN ISO 14001:2004.



**From EISELE connection components you may expect:**

- + Highest tightness and safety
- + Ruggedness and long lifetimes
- + Vacuum-compatible products
- + Easy mounting and disassembly
- + Special connections for a broad range of applications



Content overview		Page	Series
EISELE INOXLINE	 <p><b>Plug connectors made of stainless steel with 1 seal</b> All-round fittings made of stainless steel</p>	5	17
	 <p><b>Plug connectors made of stainless steel with 2 seals</b> Connections for increased pressures</p>	19	17A
	 <p><b>Screw joints</b> Screw joints with high requirements regarding the retention form</p>	29	Screw joint
	 <p><b>Connectors for connections dead zone-free</b> Fittings made of stainless steel, brass nickel-plated</p>	33	1600
	 <p><b>Comfort screw-in connectors for connections w/o gaps</b> Fittings made of stainless steel AISI 316L (1.4404)</p>	45	3800
	 <p><b>MULTILINE ADAPTIV</b> Individually compiled coupling</p>	51	ADAPTIV
	 <p><b>Accessories for the Eisele INOXLINE</b> Ideal supplement to the Eisele INOXLINE connections</p>	65	ACC
	 <p><b>Customized connection solutions</b> Customised connection solutions for the INOXLINE-Series</p>	73	CLIENT
 <p><b>Plastic tubes</b> PE, PA, PU, Eisele ProWeld, PTFE/FEP</p>	75	99	
<b>Article number index</b>		84	

For more information about our terms of sale please visit our website.





## Plug connectors made of stainless steel and 1 seal

17

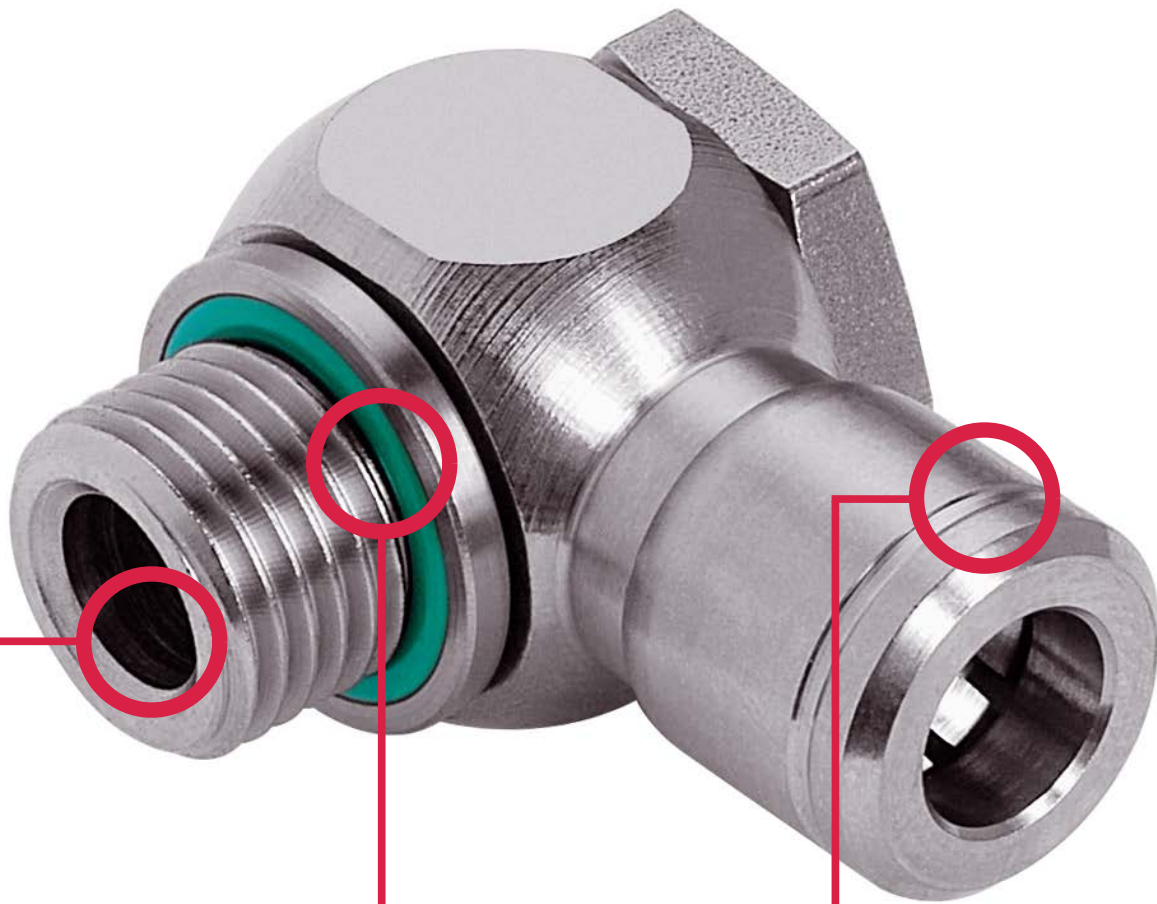

### Media-resistant materials

- For applications in the food industry
- High material quality. Use of stainless and acid-proof stainless steel AISI 304/ 304L (1.4301 / 1.4307)

### Efficient handling

- Quick and securely assembly and disassembly of tubes
- Handling does not require any tools

### With patented release sleeve

- The collet is located and well protected from the release sleeve in the casing
- Even when the connectors have been exposed to heavy soiling, dirt cannot enter the system
- Easy cleaning of connectors possible

Also suitable for vacuum applications.

## Functional principle

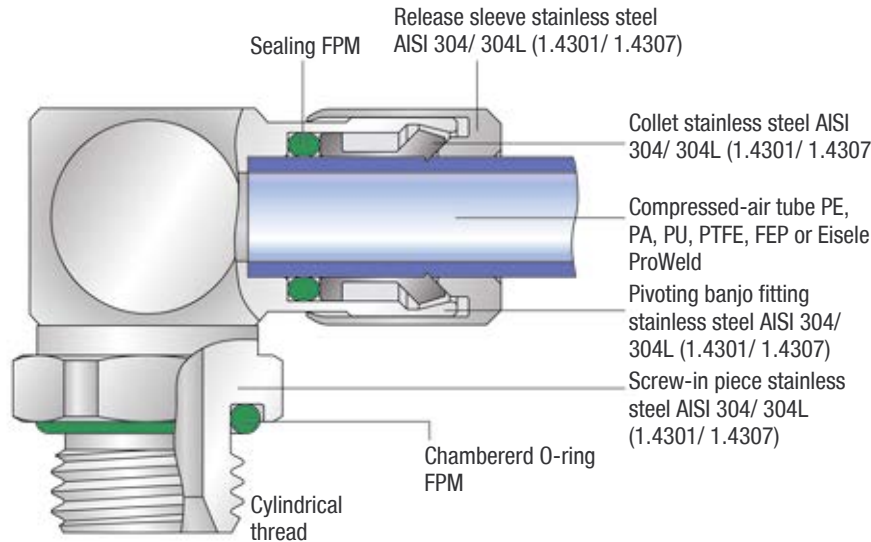

### Advantages

- Very quick assembly and disassembly of compressed-air hoses
- No tools necessary
- Frequent assembly and disassembly possible
- Full hose through-flow
- All male stud couplings with chambered O-ring sealed
- Very small connector sets
- Material stainless steel AISI 304/304L (1.4301 / 1.4307 )
- Suitable for vacuum

### Special technology of the release sleeve

- Collet lies in casing and is protected from release sleeve
- Easy disassembly even when connectors are severely soiled
- Easy to clean

## Range of application

The connection system with special technology for use in the food industry and for use with aggressive media. Very quick assembly and disassembly of compressed-air hoses made of PE (polyethylene), PA (polyamide), PU (polyurethane), ProWeld (PUR) and PTFE (Teflon) / FEP.

## Service conditions

Working pressure range: -14 to 232 psi (-0.95 to 16 bar)  
 Allowable medium: Air and other media <sup>1)</sup>  
 Temperature range: -4 to 248 °F (-20 to +120 °C)

Data provided depend on hoses used.

<sup>1)</sup> Plug connectors of this type may not only be used for compressed-air, but, after consultation, for other gaseous media too. Please enquire if the sealing material FPM is not suitable for your application. Our engineers will be happy to consult you in the selection of a suitable sealing material.

## Handling

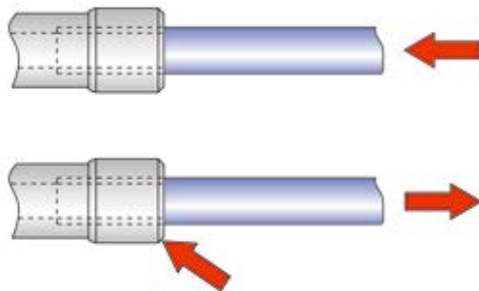

Assembly: Push tube into the connector up to the limit stop

Disassembly: Fully push back release sleeve, pull out tube

## Tubes

Tube dimension		Polyethylene (PE) Temperature range -10 to +40°C		Polyamide (PA) Temperature range -60 to +100°C		Polyurethane (PU) Temperature range -35 to +70°C		ProWeld (PUR) <sup>1)</sup> Temperature range -35 to +75°C		Teflon (PTFE) / FEP <sup>2)</sup> Temperature range -35 to +120°C	
Outside-Ø	Inside-Ø	R min.	p max. (bar)	R min.	p max. (bar)	R min.	p max. (bar)	R min.	p max. (bar)	R min.	p max. (bar)
4 (±0,1)	(2)	20	290 psi (20 bar)	20	435 psi (30 bar)	10	145 psi (10 bar)	10	290 psi (20 bar)	16	362 psi (25 bar)
4,3 (±0,1)	(3)	20	188 psi (13 bar)	20	290 psi (20 bar)	10	145 psi (10 bar)	-	-	35	145 psi (10 bar)
5 (±0,1)	(3)	25	217 psi (15 bar)	25	362 psi (25 bar)	11	145 psi (10 bar)	-	-	25	290 psi (20 bar)
6 (±0,1)	(4)	30	188 psi (13 bar)	30	290 psi (20 bar)	15	145 psi (10 bar)	15	159 psi (11 bar)	35	217 psi (15 bar)
8 (±0,15)	(6)	40	116 psi (8 bar)	40	217 psi (15 bar)	20	130 psi (9 bar)	20	130 psi (9 bar)	65	159 psi (11 bar)
10 (±0,15)	(8)	60	87 psi (6 bar)	60	174 psi (12 bar)	40	116 psi (8 bar)	25	203 psi (14 bar)	100	130 psi (9 bar)
12 (±0,15)	(9)	60	130 psi (9 bar)	85	217 psi (15 bar)	50	145 psi (10 bar)	30	145 psi (10 bar)	100	130 psi (9 bar)
14 (±0,15)	(11)	90	116 psi (8 bar)	80	174 psi (12 bar)	60	109 psi (7,5 bar)	45	130 psi (9 bar)	140	130 psi (9 bar)
16 (±0,15)	(12)	90	87 psi (6 bar)	90	159 psi (11 bar)	45	145 psi (10 bar)	50	130 psi (9 bar)	-	-
20 (±0,2)	(14)	-	-	-	-	-	-	-	116 psi (8 bar)	-	-
1/4" (6,3±0,1)	(4)	-	-	23	290 psi (20 bar)	-	-	10	145 psi (10 bar)	-	-
3/8" (9,5±0,15)	(6)	-	-	32	275 psi (19 bar)	-	-	25	130 psi (9 bar)	-	-
1/2" (12,7±0,15)	(8)	-	-	60	260 psi (19 bar)	-	-	23	130 psi (9 bar)	-	-
5/8" (15,9±0,15)	(11)	-	-	-	-	-	-	-	-	-	-

The mounted compressed-air tubes are not to be exposed to tensile loading.

<sup>1)</sup> In the case of Eisele ProWeld tubes a smaller inside diameter results from a partially larger wall thickness.

<sup>2)</sup> Important notes for the use of compressed-air tubes made of PTFE (Teflon) and FEP:

- The outside diameter of compressed-air tubes must be free of grooves and other damages (e.g. damage from installation tools).
- Prior to assembly, use the Eisele tube cutter Art. No. 99605-0014 or Art. No. 99606-0022 to cut compressed-air tubes at a right angle. Ensure that tubes are not being deformed or damaged during the cutting process.
- During assembly, compressed-air tubes must be pressed until the bottom of the plug connectors to achieve proper tightness.

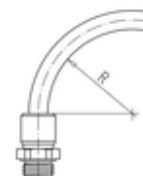

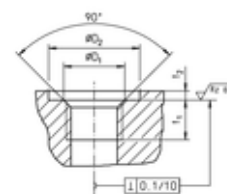

## Connection thread

Thread	Thread depth	Thread counterbore	Counterbore <sup>1)</sup>		Torque <sup>2)</sup> max. (Nm)	Thread standards
	t1 min. (mm)	ØD1 max. (mm)	ØD2 min. (mm)	t2 max. (mm)		
M5	4.5	6	10	0.5	0,95	Metric thread M: DIN 13 / ISO 965 Pipe thread G: DIN ISO 228
G1/8	7	11	15.3	0.5	9	
G1/4	9	14.2	19	0.5	18	
G3/8	9	17.5	24	0.5	25	
G1/2	11	22	27	0.5	34	



<sup>1)</sup> A counterbore is not necessary. However, the indicated values apply if a counterbore is applied.

## Threaded connectors starting on page 9

	Straight threaded connectors	page 9
	Angled threaded connectors	page 11
	Threaded T-connectors	page 12



## Plug connector starting on page 14

	Double connectors	page 14
	Elbow connectors	page 14
	T-connectors	page 15
	Cross connectors	page 15
	Bulkhead connectors	page 16

## Functional screw joints starting on page 17

	Throttle check valve	page 17
---	----------------------	---------

## Plug starting on page 18

	Reducing plug	page 18
	Elbow plug	page 18
	Sealing plug	page 18

## Accessories starting on page 52



## Screw-in connector

- Whitworth pipe thread
- Chambered O-ring
- Seals FPM
- Material stainless steel AISI 304/ 304L (1.4301/1.4307)
- Temperature range -4 to 248 °F (-20 to +120 °C)
- Working pressure range -14 to 232 psi (-0.95 to 16 bar)

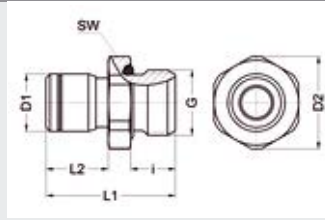

Part no.	G	for tube	SW	i	L1	L2	D1	D2	NW	g/piece
928-0202	G1/8	OD4	13	7	21	10	8,6	14,2	3	9
928-0204	G1/8	OD6	13	7	23,5	12,5	11,5	14,2	5	10
928-0204X	G1/8	OD6	13	5,5	22	12,5	11,5	14,2	5	10
928-0206	G1/8	OD8	14	7	28,5	17,5	14,5	15,2	6	15
928-0208	G1/8	OD10	15	5,5	30	19	16,5	16,2	6	20
928-0402	G1/4	OD4	17	9	23,5	10	8,6	18,5	3	18
928-0404	G1/4	OD6	17	9	26	12,5	11,5	18,5	5	19
928-0406	G1/4	OD8	17	9	29	15,5	14,5	18,5	6	21
928-0408	G1/4	OD10	17	9	33,5	20	16,5	18,5	8	23
928-0409	G1/4	OD12	19	9	37,5	22	20	20,7	8	36
928-0604	G3/8	OD6	22	9	27	12,5	11,5	23,8	5	33
928-0606	G3/8	OD8	22	9	30	15,5	14,5	23,8	6	35
928-0608	G3/8	OD10	22	9	32	17,5	16,5	23,8	8	34
928-0609	G3/8	OD12	22	9	34	19,5	20	23,8	9	37
928-0611	G3/8	OD14	22	9	41	26,5	22	23,8	11	44
928-0804	G1/2	OD6	24	11	29,5	12,5	11,5	26,2	4	51
928-0806	G1/2	OD8	24	11	32,5	15,5	14,5	26,2	6	54
928-0808	G1/2	OD10	24	11	34,5	17,5	16,5	26,2	8	52
928-0809	G1/2	OD12	24	11	36,5	19,5	20	26,2	9	54
928-0811	G1/2	OD14	24	11	38	21	22	26,2	11	52
928-0812	G1/2	OD16	24	11	42,5	26,5	24,9	26,2	12,5	62
928-0815	G1/2	OD20	30	11	61,2	39,2	30,5	33,5	12,5	130
928-1015	G3/4	OD20	32	12	61,2	38,2	30,5	34,8	16,5	145

## Screw-in connector

- Thread metric
- Chambered O-ring
- Seals FPM
- Material stainless steel AISI 304/ 304L (1.4301/1.4307)
- Temperature range -4 to 248 °F (-20 to +120 °C)
- Working pressure range -14 to 232 psi (-0.95 to 16 bar)

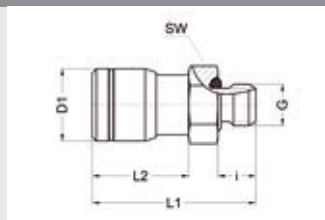

Part no.	G	for tube	SW	i	L1	L2	D1	NW	g/piece
929-4202	M3	OD4	8	3	18,5	11,5	8,6	1,2	4
929-5002	M5	OD4	8	4,5	19,5	11,5	8,6	2	4
929-5004	M5	OD6	10	4,5	23	14	11,5	2	7
929-4604	M6	OD6	10	5	23	13	11,5	3	7
929-5006	M6	OD8	13	4,5	25	16	14,5	2	9

## Screw-in connector

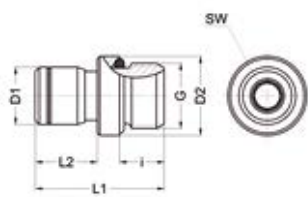

- Whitworth pipe thread
- With hexagon socket
- Chambered O-ring
- Seals FPM
- Material stainless steel AISI 304/ 304L (1.4301/1.4307)
- Temperature range -4 to 248 °F (-20 to +120 °C)
- Working pressure range -14 to 232 psi (-0.95 to 16 bar)

Part no.	G	for tube	SW	i	L1	L2	D1	D2	NW	g/piece
962-0202	G1/8	OD4	3	7	20	10	8,6	11,9	3	7
962-0204	G1/8	OD6	4	7	22,5	12,5	11,5	11,9	4	9
962-0206	G1/8	OD8	5	7	28,5	-	14,5	12,8	5	15
962-0402	G1/4	OD4	3	9	23,5	10	8,6	15,9	2,5	16
962-0404	G1/4	OD6	4	9	26	12,5	11,5	15,9	4	18
962-0406	G1/4	OD8	6	9	29	15,5	14,5	15,9	6	19
962-0408	G1/4	OD10	8	9	33,5	20	16,5	15,9	8	21
962-0604	G3/8	OD6	5	9	27	12,5	11,5	19,9	5	29
962-0606	G3/8	OD8	6	9	30	15,5	14,5	19,9	6	31
962-0608	G3/8	OD10	6	9	32	17,5	16,5	19,9	6	30
962-0609	G3/8	OD12	9	9	34	19,5	20	19,9	9	32
962-0804	G1/2	OD6	5	11	29,5	12,5	11,5	23,9	5	49
962-0806	G1/2	OD8	6	11	32,5	15,5	14,5	23,9	6	51
962-0808	G1/2	OD10	8	11	34,5	17,5	16,5	23,9	8	50
962-0809	G1/2	OD12	9	11	36,5	19,5	20	23,9	9	52

## Screw-in connector

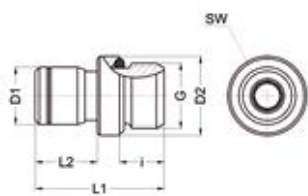

- Metric thread
- With hexagon socket
- Chambered O-ring
- Seals FPM
- Material stainless steel AISI 304/ 304L (1.4301/1.4307)
- Temperature range -4 to 248 °F (-20 to +120 °C)
- Working pressure range -14 to 232 psi (-0.95 to 16 bar)

Part no.	G	for tube	SW	i	L1	L2	D1	D2	NW	g/piece
963-5002	M5	OD4	2,5	4,5	19	11	8,8	8	2	4
963-5004	M5	OD6	2,5	4,5	23,5	14	11,6	8	2	6

## Straight screw-in connector with female thread

- Whitworth pipe thread
- Seals FPM
- Material stainless steel AISI 304/ 304L (1.4301/1.4307)
- Temperature range -4 to 248 °F (-20 to +120 °C)
- Working pressure range -14 to 232 psi (-0.95 to 16 bar)

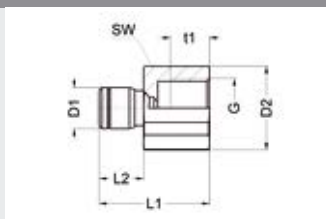

17

Part no.	G	for tube	SW	L1	L2	t1	D1	D2	NW	g/piece
917-0102	G1/8	OD4	14	24	10	7	8,6	15,2	2,5	15
917-0104	G1/8	OD6	14	27	12,5	7	11,5	15,2	4	18
917-0106	G1/8	OD8	14	30	15,5	7	14,5	15,2	6	21
917-0304	G1/4	OD6	17	31	12,5	11	11,5	18,3	4	27
917-0306	G1/4	OD8	17	34	15,5	11	14,5	18,3	6	31
917-0308	G1/4	OD10	17	37	17,5	11	16,5	18,3	8	34
917-0504	G3/8	OD6	22	31	12,5	11	11,5	23,4	4	43
917-0506	G3/8	OD8	22	34	15,5	11	14,5	23,4	6	46
917-0508	G3/8	OD10	22	37	17,5	11	16,5	23,4	8	50
917-0704	G1/2	OD6	27	34	12,5	13	11,5	28,6	4	68
917-0706	G1/2	OD8	27	37	15,5	13	14,5	28,6	6	72
917-0708	G1/2	OD10	27	40	17,5	13	16,5	28,6	8	77

## Elbow screw-in connector swiveling

- Whitworth pipe thread
- Chambered O-ring
- Seals FPM
- Material stainless steel AISI 304/ 304L (1.4301/1.4307)
- Temperature range -4 to 248 °F (-20 to +120 °C)
- Working pressure range -14 to 232 psi (-0.95 to 16 bar)
- Not designed for steady motion of the tube

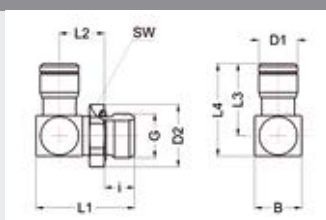

Part no.	G	for tube	SW	i	L1	L2	L3	L4	B	D1	D2	NW	g/piece
986-0202	G1/8	OD4	13	7	23	11	17	21,5	10	8,6	14,2	2,5	16
986-0204	G1/8	OD6	13	7	27	13	21,3	27,3	14	11,5	14,2	4	28
986-0204X	G1/8	OD6	13	5,5	25	13	21,3	27,3	14	11,5	14,2	4	28
986-0206	G1/8	OD8	13	7	29,5	14,5	25,5	33	16	14,5	14,2	5,5	40
986-0208	G1/8	OD10	17	7	31,4	15,4	29,5	38	18	16,5	18,5	5,5	57
986-0209	G1/8	OD12	17	7	33,9	16,9	35,5	45,5	20	20	18,5	5,5	81
986-0402	G1/4	OD4	17	9	26	12	17	21,5	10	8,6	18,5	2,5	23
986-0404	G1/4	OD6	17	9	29,5	13,5	21,3	27,3	14	11,5	18,5	4	36
986-0406	G1/4	OD8	17	9	32	15	25,5	33	16	14,5	18,5	6	48
986-0408	G1/4	OD10	17	9	34	16	29,5	38	18	16,5	18,5	8	57
986-0409	G1/4	OD12	17	9	36,5	17,5	35,5	45,5	20	20	18,5	9	80
986-0604	G3/8	OD6	22	9	29,4	13,5	21,3	27,3	14	11,5	23,8	4	48
986-0604X	G3/8	OD6	22	7,5	28	13,5	21,3	27,3	14	11,5	23,8	4	46
986-0606	G3/8	OD8	22	9	32,5	15,5	25,5	33	16	14,5	23,8	6	58
986-0608	G3/8	OD10	22	9	34,5	16,5	29,5	38	18	16,5	23,8	8	69
986-0609	G3/8	OD12	22	9	37	18	35,5	45,5	20	20	23,8	9	92
986-0611	G3/8	OD14	22	9	41,5	20,5	39,4	52	22	22	23,8	12	127
986-0612	G3/8	OD16	22	9	41,5	20,5	43	55	24	24,9	23,8	12	134
986-0806	G1/2	OD8	24	11	35,5	16,5	25,5	33	16	14,5	26,2	6	73
986-0808	G1/2	OD10	24	11	37,5	17,5	29,5	38	18	16,5	26,2	8	84
986-0809	G1/2	OD12	24	11	40	19	35,5	45,5	20	20	26,2	9	108
986-0811	G1/2	OD14	24	11	43,5	20,5	39,4	52	22	22	26,2	12	144
986-0812	G1/2	OD16	24	11	43,5	20,5	43	55	24	24,9	26,2	12	151
986-0815	G1/2	OD20	24	11	48	23,5	51	65	30	20	30,5	12	215

## Elbow screw-in connector, swiveling

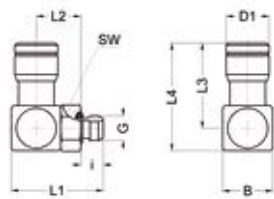

- Metric thread
- Chambered O-ring
- Seals FPM
- Material stainless steel AISI 304/ 304L (1.4301/1.4307)
- Temperature range -4 to 248 °F (-20 to +120 °C)
- Working pressure range -14 to 232 psi (-0.95 to 16 bar)
- Not designed for steady motion of the tube

17

Part no.	G	for tube	SW	i	L1	L2	L3	L4	B	D1	NW	g/piece
987-4202	M3	OD4	8	3	17	9	17	21,5	10	8,6	1,2	10
987-5002	M5	OD4	8	4,5	18,5	9	17	21,5	10	8,6	2	10
987-5004	M5	OD6	8	4,5	20,5	10	20	24,5	12	11,5	2	15
987-4604	M6	OD6	10	5	21,9	10,9	20	24,5	12	11,5	3	17

## T-screw-in connector, swiveling

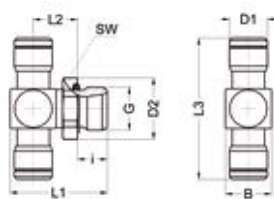

- Whitworth pipe thread
- Chambered O-ring
- Seals FPM
- Material stainless steel AISI 304/ 304L (1.4301/1.4307)
- Temperature range -4 to 248 °F (-20 to +120 °C)
- Working pressure range -14 to 232 psi (-0.95 to 16 bar)
- Not designed for steady motion of the tube

Part no.	G	for tube	SW	i	L1	L2	L3	B	D1	D2	NW	g/piece
988-0202	G1/8	OD4	13	7	23	11	34	10	8,6	14,2	2,5	18
988-0204	G1/8	OD6	13	7	27	13	42,6	14	11,5	14,2	4	33
988-0206	G1/8	OD8	13	7	29,5	14,5	51	16	14,5	14,2	5,5	49
988-0402	G1/4	OD4	17	9	26	12	34	10	8,6	18,5	2,5	26
988-0404	G1/4	OD6	17	9	29,5	13,5	42,6	14	11,5	18,5	4	41
988-0406	G1/4	OD8	17	9	32	15	51	16	14,5	18,5	6	56
988-0408	G1/4	OD10	17	9	34	16	59	18	16,5	18,5	8	59
988-0409	G1/4	OD12	17	9	36,5	17,5	71	20	20	18,5	9	100
988-0606	G3/8	OD8	22	9	32,5	15,5	51	16	14,5	23,8	6	67
988-0608	G3/8	OD10	22	9	34,5	16,5	59	18	16,5	23,8	8	80
988-0609	G3/8	OD12	22	9	37	18	71	20	20	23,8	9	112
988-0806	G1/2	OD8	24	11	35,5	16,5	51	16	14,5	26,2	6	82
988-0808	G1/2	OD10	24	11	37,5	17,5	59	18	16,5	26,2	8	96
988-0809	G1/2	OD12 (12/9)	24	11	40	19	71	20	20	26,2	9	128

## T-screw-in connector, swiveling

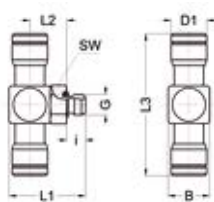

- Metric thread
- Chambered O-ring
- Seals FPM
- Material stainless steel AISI 304/ 304L (1.4301/1.4307)
- Temperature range -4 to 248 °F (-20 to +120 °C)
- Working pressure range -14 to 232 psi (-0.95 to 16 bar)
- Not designed for steady motion of the tube

Part no.	G	for tube	SW	i	L1	L2	L3	B	D1	NW	g/piece
989-4202	M3	OD4	8	4,5	17	9	32	10	8,6	1,2	10
989-5002	M5	OD4	8	4,5	18,5	9	34	10	8,6	2	12
989-5004	M5	OD6	8	4,5	20,5	10	40	12	11,5	2	21

## Single swivel connector, short model

- Whitworth pipe thread
- VS-seal ring
- Seals FPM
- Material stainless steel AISI 304/ 304L (1.4301/1.4307)
- Temperature range -4 to 248 °F (-20 to +120 °C)
- Working pressure range -14 to 232 psi (-0.95 to 16 bar)

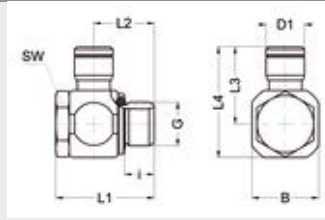

Part no.	G	for tube	SW	i	L1	L2	L3	L4	B	D1	NW	g/piece
934-0202K	G1/8	OD4	13	7	27	15	18,2	26,2	16	8,6	2	32
934-0204K	G1/8	OD6	13	7	27	15	21	29	16	11,5	4	34
934-0206K	G1/8	OD8	13	7	27	15	24	32	16	14,5	5,2	37
934-0208K	G1/8	OD10	13	7	28,5	15	27	35	16	16,6	5,2	48
934-0402K	G1/4	OD4	17	9	29,5	18	20	30	20	8,6	2	48
934-0404K	G1/4	OD6	17	9	29,5	18	23	33	20	11,5	4	51
934-0406K	G1/4	OD8	17	9	29,5	18	26	36	20	14,5	6	54
934-0408K	G1/4	OD10	17	9	29,5	18	28,5	38,5	20	16,5	7,2	56
934-0409K	G1/4	OD12	17	9	35	19,3	33,5	43,5	20	19,9	7,4	87

## Single swivel connector, short model

- Metric thread
- VS-seal ring
- Seals FPM
- Material stainless steel AISI 304/ 304L (1.4301/1.4307)
- Temperature range -4 to 248 °F (-20 to +120 °C)
- Working pressure range -14 to 232 psi (-0.95 to 16 bar)

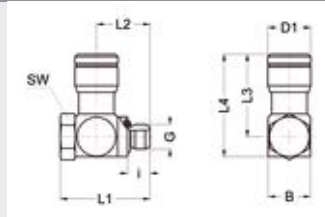

Part no.	G	for tube	SW	i	L1	L2	L3	L4	B	D1	NW	g/piece
935-5002K	M5	OD4	8	4,5	18	6,2	16,5	20,5	8,5	8,6	2	8
935-5004K	M5	OD6	8	4,5	19,5	7	19,5	24	11	11,5	2	13



## Double connector

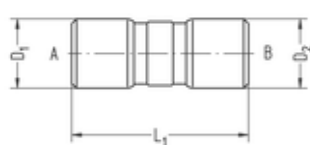

- Seals FPM
- Material stainless steel AISI 304/ 304L (1.4301/1.4307)
- Temperature range -4 to 248 °F (-20 to +120 °C)
- Working pressure range -14 to 232 psi (-0.95 to 16 bar)

Part no.	for tube A	for tube B	L1	D1	D2	NW	g/piece
932-0204	OD4	OD6	30,5	8,6	11,5	2,5	10
932-0406	OD6	OD8	35,5	11,5	14,5	4	19
932-0408	OD6	OD10	38,5	11,5	16,5	4	23
932-0608	OD8	OD10	42,5	14,5	16,5	6	28
932-0609	OD8	OD12	47,5	14,5	20	6	42
932-0809	OD10	OD12	50	16,5	20	8	45
933-0202	OD4	OD4	27	8,6	8,6	2,5	6
933-0404	OD6	OD6	33	11,5	11,5	4	12
933-0606	OD8	OD8	39	14,5	14,5	6	22
933-0808	OD10	OD10	44,5	16,5	16,5	8	30
933-0909	OD12	OD12	54,5	20	20	9	53
933-1212	OD16	OD16	65,5	25	25	12	92
933-1818	OD3	OD3	23	6,8	6,8	2	6

## Elbow connector

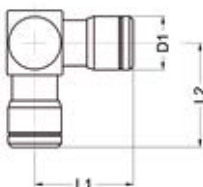

- Seals FPM
- Material stainless steel AISI 304/ 304L (1.4301/1.4307)
- Temperature range -4 to 248 °F (-20 to +120 °C)
- Working pressure range -14 to 232 psi (-0.95 to 16 bar)

Part no.	for tube	L1	L2	D1	NW	g/piece
977-0200	OD4	17	17,5	8,6	2,5	11
977-0400	OD6	21,3	22,5	11,5	4	26
977-0600	OD8	25,5	26	14,5	6	42
977-0800	OD10	29,5	30,5	16,5	8	57
977-0900	OD12	35,5	36	20	9	89
977-1100	OD14	38	38	22	11	112
977-1200	OD16	43	45,3	24,9	12	154

## T-connector

- Seals FPM
- Material stainless steel AISI 304/ 304L (1.4301/1.4307)
- Temperature range -4 to 248 °F (-20 to +120 °C)
- Working pressure range -14 to 232 psi (-0.95 to 16 bar)

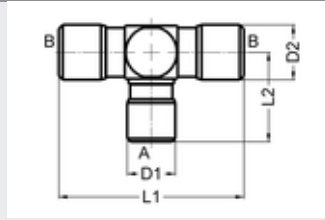

Part no.	for tube A	for tube B	L1	L2	D1	D2	NW	g/piece
978-0200	OD4	OD4	34	17,5	8,6	8,6	2,5	13
978-0204	OD4	OD6	39,8	18,4	8,6	11,5	3	21
978-0400	OD6	OD6	42,6	22,5	11,5	11,5	4	31
978-0600	OD8	OD8	51	26	14,5	14,5	6	50
978-0800	OD10	OD10	59	30,5	16,5	16,5	8	68
978-0900	OD12	OD12	71	36	20	20	9	110
978-1100	OD14	OD14	76	37,5	22	22	11	139
978-1200	OD16	OD16	86	45,3	24,9	24,9	12	187
978-1800	OD3	OD3	27,6	14,3	6,8	6,8	2	7

## 4-way connector

- Seals FPM
- Material stainless steel AISI 304/ 304L (1.4301/1.4307)
- Temperature range -4 to 248 °F (-20 to +120 °C)
- Working pressure range -14 to 232 psi (-0.95 to 16 bar)

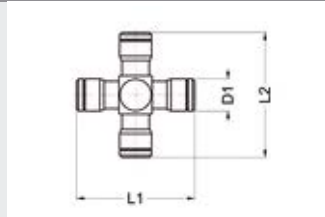

Part no.	for tube	L1	L2	D1	NW	g/piece
979-0400	OD6	42,6	44,8	11,5	4	35

## Y-connector

- Seals FPM
- Material stainless steel AISI 304/ 304L (1.4301/1.4307)
- Temperature range -4 to 248 °F (-20 to +120 °C)
- Working pressure range -14 to 232 psi (-0.95 to 16 bar)

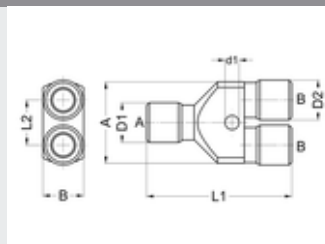

Part no.	for tube A	for tube B	L1	L2	D1	D2	A	B	d1	NW	g/piece
975-0404	OD6	OD6	44	13,2	11,5	11,5	25	10	4,2	4	67
975-0606	OD8	OD8	55	16,5	14,5	14,5	31,8	15	5,2	6	79

## Bulkhead connector

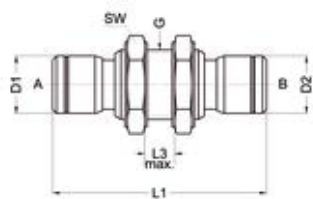

- Seals FPM
- Material stainless steel AISI 304/ 304L (1.4301/1.4307)
- Temperature range -4 to 248 °F (-20 to +120 °C)
- Working pressure range -14 to 232 psi (-0.95 to 16 bar)

Part no.	for tube A	for tube B	G	SW	L1	L3 max.	D1	D2	NW	g/piece
980-0202	OD4	OD4	M12x1	14	34	6	8,6	8,6	2,5	19
980-0404	OD6	OD6	M14x1	17	43	8	11,5	11,5	4	35
980-0606	OD8	OD8	M16x1	19	49	8	14,5	14,5	6	47
980-0808	OD10	OD10	M18x1	22	56	10	16,5	16,5	8	65
980-0909	OD12	OD12	M22x1	27	63	12	20	20	9	109
980-1111	OD14	OD14	M24x1	30	66	12	22	22	11	127
980-1212	OD16	OD16	M28x1	32	72	12	24,9	24,9	12	162
980-1515	OD20	OD20	M34x1	41	102,4	15	30,5	30,5	16,5	311
981-0204	OD4	OD6	M14x1	17	40,5	8	8,6	11,5	2,5	26
981-0406	OD6	OD8	M16x1	19	46	8	11,5	14,5	4	35
981-0608	OD8	OD10	M18x1	22	54	10	14,5	16,5	6	51
981-0809	OD10	OD12	M22x1	27	61	12	16,5	20	8	84

## Elbow bulkhead connector, swiveling

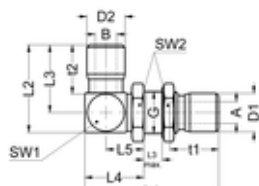

- Seals FPM
- Material stainless steel AISI 304/ 304L (1.4301/1.4307)
- Temperature range -4 to 248 °F (-20 to +120 °C)
- Working pressure range -14 to 232 psi (-0.95 to 16 bar)

Part no.	for tube A	for tube B	G	SW1	SW2	L1	L2	L3	L3 max.	L4	D1	D2	t1	t2	NW	g/piece
914-0606	OD8	OD8	M16x1	16	19	50,4	33	25,5	7	22,4	14,5	14,5	18,5	18,5	6	75

## L screw-in connector, pivoting

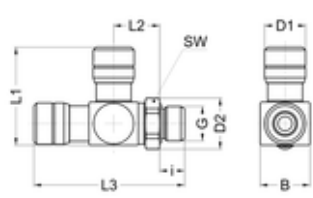

- Whitworth pipe thread
- Chambered O-ring
- Seals FPM
- Material stainless steel AISI 304/ 304L (1.4301/1.4307)
- Temperature range -4 to 248 °F (-20 to +120 °C)
- Working pressure range -14 to 232 psi (-0.95 to 16 bar)
- Not designed for steady motion of the tube

Part no.	G	for tube	SW	i	L1	L2	L3	D1	D2	B	NW	g/piece
990-0204	G1/8	OD6	13	7	27	12,9	42,3	11,5	14,2	14	4	33

## Single swivel connector with throttle check valve

- Short design (exhaust-side throttle)
- Slotted adjusting screw
- Whitworth-pipe thread
- VS seal rings (FPM)
- Seal in connection FPM
- Material: AISI 304/304L (1.4301/ 1.4307)
- Type: Cone-type throttle
- Allowable medium: Air
- Temperature range: -4 to 176 °F (-20 to +80 °C)
- Working pressure range: 7 to 145 psi (0,5 to 10 bar)

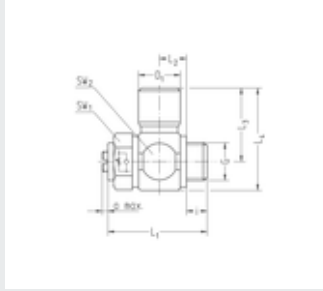

Part no.	G	for tube	NI/min 1->2	NI/min 2->1	SW1	SW2	i	L1	L2	L3	L4	D1	a max.	NW	g/piece
VT234-0202K934	G1/8	OD4	200	150	14	16	6	32	9,5	18,2	26,2	8,5	2	2	40
VT234-0204K934	G1/8	OD6	200	150	14	16	6	32	9,5	21	29	11,5	2	3	43
VT234-0206K934	G1/8	OD8	200	150	14	16	6	32	9,5	24	32	14,5	2	3	47
VT234-0208K934	G1/8	OD10	200	150	14	16	6	32	9,5	27	35	16,5	2	3	49
VT234-0402K934	G1/4	OD4	400	300	17	20	8	35,5	9,5	20	30	8,5	2	2	62
VT234-0404K934	G1/4	OD6	400	300	17	20	8	35,5	9,5	23	33	11,5	2	4	64
VT234-0406K934	G1/4	OD8	400	300	17	20	8	35,5	9,5	26	36	14,5	2	4,5	68
VT234-0408K934	G1/4	OD10	400	300	17	20	8	35,5	9,5	28,5	38,5	16,5	2	4,5	70

## Reducing plug

- Seals FPM
- Material stainless steel AISI 304/ 304L (1.4301/1.4307)
- Temperature range -4 to 248 °F (-20 to +120 °C)
- Working pressure range -14 to 232 psi (-0.95 to 16 bar)
- Fits all Eisele plug connectors

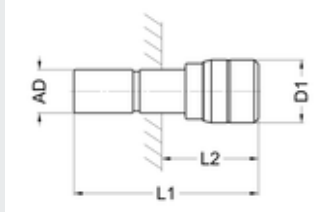

Part no.	plug AD	for tube	L1	L2	D1	NW	g/piece
921-0204	4	OD6	34	11,5	11,5	2,5	7
921-0402	6	OD4	31,5	8,6	8,6	3	5
921-0602	8	OD4	34,5	8,6	8,6	3	7
921-0604	8	OD6	39	11,5	11,5	4,5	10
921-0804	10	OD6	40	11,5	11,5	4,5	12
921-0806	10	OD8	43	14,5	14,5	6,5	15
921-0906	12	OD8	48	14,5	14,5	6,5	20
921-0908	12	OD10	51	16,5	16,5	8,5	23
921-1209	16	OD12	60	24	20	9	52

## Double plug

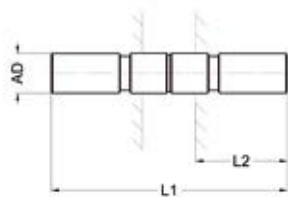

- Material stainless steel AISI 304/ 304L (1.4301/1.4307)
- Temperature range -4 to 248 °F (-20 to +120 °C)
- Working pressure range -14 to 232 psi (-0.95 to 16 bar)

Part no.	plug AD	L1	L2	NW	g/piece
922-0202	4	30	12,2	2,5	1
922-0404	6	36	15	4	4
922-0606	8	41	17,2	6	7
922-0808	10	47	19	8	10
922-0909	12	60	24	9	23
922-1111	14	64	28,5	11	59

## Sealing plug

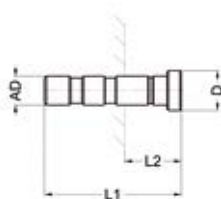

- Material stainless steel AISI 304/ 304L (1.4301/1.4307)
- Temperature range -4 to 248 °F (-20 to +120 °C)
- Working pressure range -14 to 232 psi (-0.95 to 16 bar)

Part no.	plug AD	L1	L2	D	g/piece
923-0200	4	19	6,8	5,5	2
923-0400	6	21,5	6,5	8	5
923-0600	8	24,5	7,2	10	10
923-0800	10	28	9	12	17
923-0900	12	33	9	14	30
923-1100	14	36	7,5	16	44

## Elbow plug

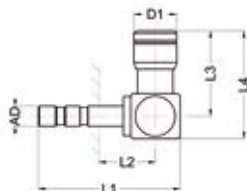

- Seals FPM
- Material stainless steel AISI 304/ 304L (1.4301/1.4307)
- Temperature range -4 to 248 °F (-20 to +120 °C)
- Working pressure range -14 to 232 psi (-0.95 to 16 bar)

Part no.	plug AD	for tube	L1	L2	L3	L4	D1	NW	g/piece
941-0202	4	OD4	28,5	16	17	21,5	8,6	2,5	9



## Plug connectors made of stainless steel and 2 seals

17A

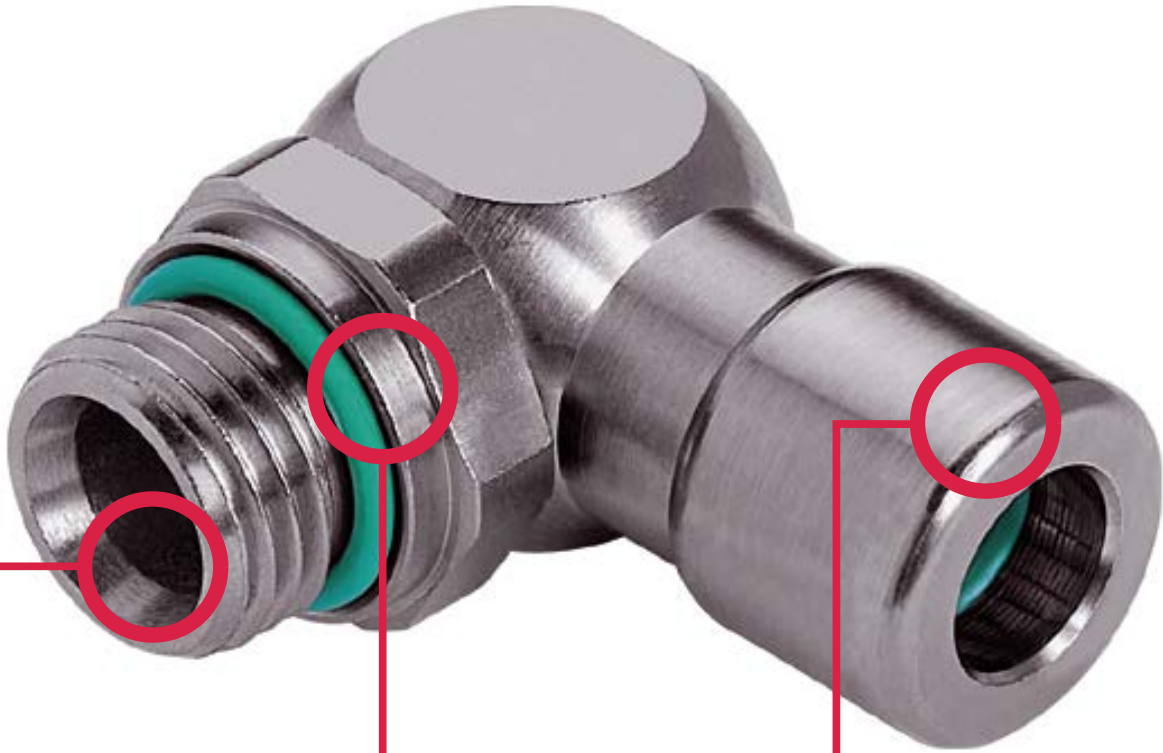

### Additional seal

- A second FPM seal ring in front of the holding clamp additionally protects from dirt entering
- In the sealing area no scratch marks on the hose outside diameter

### Extended application possibilities

- Suitable for compressed air (up to 348 psi (24 bar)) and certain fluids, also for high pressures, depending on application and hose up to 1450 psi (100 bar)
- Also suitable for vacuum

### Minimizing leakage

- High seal-tightness of connections e.g. for low-pressure hydraulics, central lubrication

Also suitable for vacuum applications.

## Functional principle

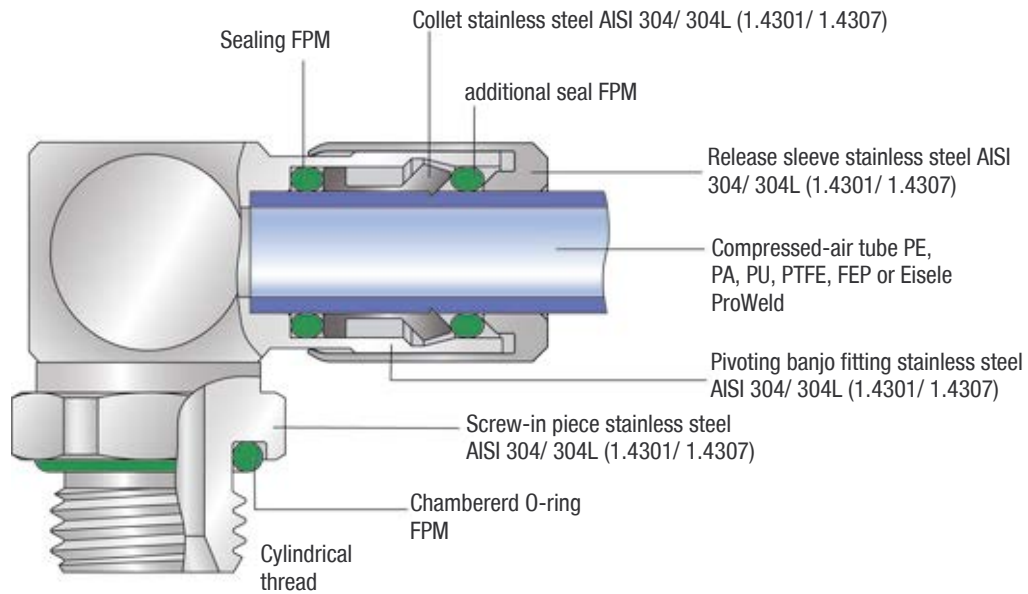

### Advantages

- Very quick assembly and disassembly of compressed-air hoses
- No tools necessary
- Frequent assembly and disassembly possible
- Full hose through-flow
- All male stud couplings sealed with chambered O-ring
- Very small connector sets even if conical threads are not used
- Connector casings made of stainless steel AISI 304/ 304L (1.4301/ 1.4307)
- Wider pressure range
- Suitable for vacuum

### Special technology of the release sleeve

- Collet lies in casing and is protected from release sleeve
- Easy disassembly even when connectors are severely soiled
- Designed for easy cleaning

### Special technology with additional seal

- Additional seal located prior to holding clamp
- Scratch marks are not possible on the hose outside diameter
- Additional safety from dirt entering the system

## Range of application

The connection system with a special technology, with additional seal and a wider pressure range. Very quick assembly and disassembly of compressed-air hoses made of PE (polyethylene), PA (polyamide), PU (polyurethane), ProWeld (PUR) and PTFE (Teflon) / FEP.

## Service conditions

Working pressure range: -14 to 348 psi (-0.95 to 24 bar)<sup>1)</sup>  
 Allowable medium: Air<sup>2)</sup>  
 Temperature range: -4 to 248 °F (-20 to +120 °C)

Data provided apply depending on the compressed-air hoses used

<sup>1)</sup> Depending on the fittings and hoses used, pressures up to 1450 psi (100 bar) are possible when working with fluids. Please enquire.

<sup>2)</sup> May also be used with certain fluids. Please enquire.

If the sealing material FPM is not suitable for your application we kindly ask you to enquire. Our engineers will be happy to consult you in the selection of a suitable sealing material.

## Tubes

Tube dimension		Polyethylene (PE) Temperature range -10 to +40°C		Polyamide (PA) Temperature range -60 to +100°C		Polyurethane (PU) Temperature range -35 to +70°C		ProWeld (PUR) <sup>1)</sup> Temperature range -35 to +75°C		Teflon (PTFE) /FEP <sup>2)</sup> Temperature range -35 to +120°C	
Outside-Ø	Inside-Ø	R min.	p max. (bar)	R min.	p max. (bar)	R min.	p max. (bar)	R min.	p max. (bar)	R min.	p max. (bar)
4 (±0,1)	(2)	20	290 psi (20 bar)	20	435 psi (30 bar)	10	145 psi (10 bar)	10	290 psi (20 bar)	16	362 psi (25 bar)
4,3 (±0,1)	(3)	20	188 psi (13 bar)	20	290 psi (20 bar)	10	145 psi (10 bar)	-	-	35	145 psi (10 bar)
5 (±0,1)	(3)	25	217 psi (15 bar)	25	362 psi (25 bar)	11	145 psi (10 bar)	-	-	25	290 psi (20 bar)
6 (±0,1)	(4)	30	188 psi (13 bar)	30	290 psi (20 bar)	15	145 psi (10 bar)	15	159 psi (11 bar)	35	217 psi (15 bar)
8 (±0,15)	(6)	40	116 psi (8 bar)	40	217 psi (15 bar)	20	130 psi (9 bar)	20	130 psi (9 bar)	65	159 psi (11 bar)
10 (±0,15)	(8)	60	87 psi (6 bar)	60	174 psi (12 bar)	40	116 psi (8 bar)	25	203 psi (14 bar)	100	130 psi (9 bar)
12 (±0,15)	(9)	60	130 psi (9 bar)	85	217 psi (15 bar)	50	145 psi (10 bar)	30	145 psi (10 bar)	100	130 psi (9 bar)
14 (±0,15)	(11)	90	116 psi (8 bar)	80	174 psi (12 bar)	60	109 psi (7,5 bar)	45	130 psi (9 bar)	140	130 psi (9 bar)
16 (±0,15)	(12)	90	87 psi (6 bar)	90	159 psi (11 bar)	45	145 psi (10 bar)	50	130 psi (9 bar)	-	-
20 (±0,2)	(14)	-	-	-	-	-	-	-	116 psi (8 bar)	-	-
1/4" (6,3±0,1)	(4)	-	-	23	290 psi (20 bar)	-	-	10	145 psi (10 bar)	-	-
3/8" (9,5±0,15)	(6)	-	-	32	275 psi (19 bar)	-	-	25	130 psi (9 bar)	-	-
1/2" (12,7±0,15)	(8)	-	-	60	260 psi (19 bar)	-	-	23	130 psi (9 bar)	-	-
5/8" (15,9±0,15)	(11)	-	-	-	-	-	-	-	-	-	-

The mounted compressed-air tubes are not to be exposed to tensile loading.

<sup>1)</sup> In the case of Eisele ProWeld tubes a smaller inside diameter results from a partially larger wall thickness.

<sup>2)</sup> Important notes for the use of compressed-air tubes made of PTFE (Teflon) and FEP:

- The outside diameter of compressed-air tubes must be free of grooves and other damages (e.g. damage from installation tools).
- Prior to assembly, use the Eisele tube cutter Art. No. 99605-0014 or Art. No. 99606-0022 to cut compressed-air tubes at a right angle. Ensure that tubes are not being deformed or damaged during the cutting process.
- During assembly, compressed-air tubes must be pressed until the bottom of the plug connectors to achieve proper tightness.

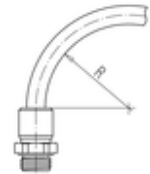

## Connection thread

Thread	Thread depth		Thread counterbore		Counterbore <sup>1)</sup>		Torque <sup>2)</sup> max. (Nm)	Thread standards
	t1 min. (mm)	t2 max. (mm)	ØD1 max. (mm)	ØD2 min. (mm)	t1 min. (mm)	t2 max. (mm)		
M5	4.5		6	10	0.5		0,95	Metric thread M: DIN 13 / ISO 965
M7	5		8	12	0.5		2	
M8x1	5.5		9.2	13	0.5		6,5	Pipe thread G: DIN ISO 228
M10x1	5.5		11	15	0.5		9	
G1/8	5.5		11	15.3	0.5		9	
G1/4	7.5		14.2	19	0.5		18	
G3/8	7.5		17.5	24	0.5		25	
G1/2	9.5		22	27	0.5		34	

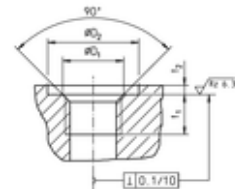

<sup>1)</sup> A counterbore is not necessary. However, the indicated values apply if a counterbore is applied.

<sup>2)</sup> Information about torques for hexagon socket on demand (assembly instructions MV800-01)

## Handling

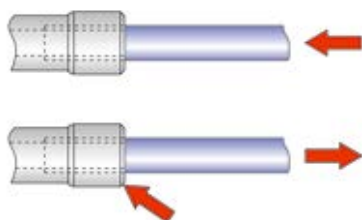

Assembly: Push hose into the connector up to the limit stop

Disassembly: Push release sleeve, pull out hose

## Threaded connectors

starting on page 23



Straight threaded connectors

page 23



Angled threaded connectors

page 25

17A

## Plug connector

starting on page 26



Double connectors

page 26



Elbow connectors

page 26



T-connectors

page 27



Bulkhead connectors

page 27



Bulkhead connector with female thread

page 28

## Plug

starting on page 28



Reducing plug

page 28

## Accessories

starting on page 52

## Screw-in connector

- Whitworth pipe thread
- Chambered O-ring
- Seals FPM
- Material AISI 304/ 304L (1.4301 / 1.4307)
- Temperature range -4 to 248 °F (-20 to +120 °C)
- Working pressure range -14 to 348 psi (-0.95 to 24 bar)

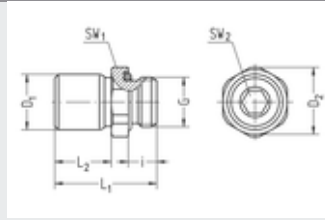

Part no.	G	for tube	SW1	SW2	i	L1	L2	D1	D2	NW	g/piece
VT1728-0202	G1/8	OD4	13	3	5,5	19	9,3	8,8	14,2	3	9
VT1728-0204	G1/8	OD6	13	5	5,5	24,5	15	11,6	14,2	4	12
VT1728-0206	G1/8	OD8	14	5	5,5	29	19	14,8	15,2	5	18
VT1728-0208	G1/8	OD10	15	5	7	33,5	21	16,8	16,4	6	24
VT1728-0402	G1/4	OD4	17	3	7,5	21,5	9,5	8,8	18,5	3	16
VT1728-0404	G1/4	OD6	17	5	7,5	23,5	11,5	11,6	18,5	5	17
VT1728-0406	G1/4	OD8	17	6	7,5	27,5	15,5	14,8	18,5	6	20
VT1728-0408	G1/4	OD10	17	8	7,5	34	22	16,8	18,5	8,5	25
VT1728-0409	G1/4	OD12	20	8	7,5	38,5	23,5	20,1	21,8	8	38
VT1728-0604	G3/8	OD6	20	5	7,5	25	11,5	11,6	21,8	5	27
VT1728-0606	G3/8	OD8	22	6	7,5	28	15	14,8	23,4	6	33
VT1728-0608	G3/8	OD10	22	8	7,5	30,5	18	16,8	23,4	8,5	34
VT1728-0609	G3/8	OD12	22	9	7,5	37,5	22	20,1	24	9	45
VT1728-0804	G1/2	OD6	24	5	9,5	28	12,6	11,6	26,2	5	47
VT1728-0806	G1/2	OD8	24	6	9,5	31	15	14,8	26,2	6	49
VT1728-0808	G1/2	OD10	24	8	9,5	32	16,6	16,8	26,2	8,5	49
VT1728-0809	G1/2	OD12	24	9	9,5	37	21	20,1	26,2	9	52
VT1728-0811	G1/2	OD14	24	11	9,5	44	28	22,1	26,2	11	60
VT1728-0812	G1/2	OD16	24	12	9,5	49	33	25,1	26,2	12,5	73

17A

## Screw-in connector

- Metric thread
- Chambered O-ring
- Seals FPM
- Material AISI 304/ 304L (1.4301 / 1.4307)
- Temperature range -4 to 248 °F (-20 to +120 °C)
- Working pressure range -14 to 348 psi (-0.95 to 24 bar)

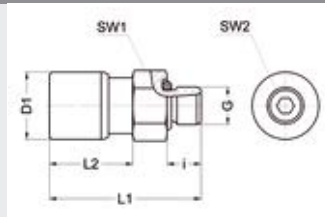

Part no.	G	for tube	SW1	SW2	i	L1	L2	D1	NW	g/piece
VT1729-5002	M5	OD4	8	2,5	4,5	20,7	11,7	8,8	2,5	5
VT1729-5004	M5	OD6	10	2,5	4,5	24,5	14,5	11,6	2,5	8
VT1729-4802	M7	OD4	10	3	5	20	10,5	8,8	2	6
VT1729-4804	M7	OD6	10	3	5	24	14,5	11,6	3	10
VT1729-5202	M8	OD4	11	3	5,5	18,5	9,5	8,8	2	6
VT1729-5204	M8	OD6	11	3	5,5	25,5	14,5	11,6	3	10



## Screw-in connector

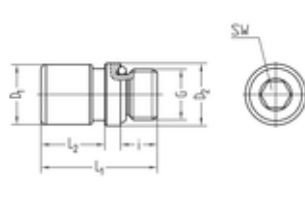

- Whitworth pipe thread
- With hexagon socket
- Chambered O-ring
- Seals FPM
- Material AISI 304/ 304L (1.4301 / 1.4307)
- Temperature range -4 to 248 °F (-20 to +120 °C)
- Working pressure range -14 to 348 psi (-0.95 to 24 bar)

17A

Part no.	G	for tube	SW	i	L1	L2	D1	D2	NW	g/piece
VT1762-0202	G1/8	OD4	3	5,5	19	9,5	8,8	11,9	2,5	7
VT1762-0204	G1/8	OD6	5	5,5	24,8	14,8	11,6	11,9	5	10
VT1762-0206	G1/8	OD8	5	5,5	28,5	-	14,8	11,9	5	15
VT1762-0208	G1/8	OD10	5	5,5	33,5	-	16,8	14	5,5	22
VT1762-0402	G1/4	OD4	3	7,5	21,5	9,5	8,8	15,9	3	15
VT1762-0404	G1/4	OD6	5	7,5	24	12	11,6	15,9	5,5	15
VT1762-0406	G1/4	OD8	6	7,5	27	14	14,8	15,9	6	20
VT1762-0408	G1/4	OD10	8	7,5	34	20,5	16,8	15,9	8	24
VT1762-0409	G1/4	OD12	8	7,5	39	-	20,1	18,1	8,5	35
VT1762-0606	G3/8	OD8	6	7,5	26,5	14	14,8	19,9	6	27
VT1762-0608	G3/8	OD10	8	7,5	30	17,5	16,8	19,9	8	29
VT1762-0609	G3/8	OD12	9	7,5	38,5	25,5	20,1	19,9	9	40

## Screw-in connector

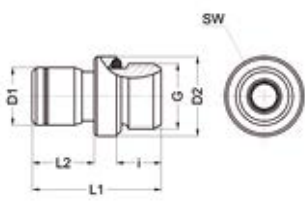

- Metric thread
- With hexagon socket
- Chambered O-ring
- Seals FPM
- Material stainless steel AISI 304/ 304L (1.4301/1.4307)
- Temperature range -4 to 248 °F (-20 to +120 °C)
- Working pressure range -14 to 232 psi (-0.95 to 16 bar)

Part no.	G	for tube	SW	i	L1	L2	D1	D2	NW	g/piece
VT1763-5002	M5	OD4	2,5	4,5	21	14	8,8	7,9	2,5	4
VT1763-5004	M5	OD6	2,5	4,5	24,5	-	11,6	7,9	2,5	7
VT1763-4602	M6	OD4	3	4,5	20	12	8,8	8,9	3	5
VT1763-4802	M7	OD4	3	5	20,5	10,5	8,8	9,9	2	7
VT1763-4804	M7	OD6	4	5	24,8	-	11,6	10	4	8
VT1763-5202	M8x1	OD4	3	5,5	20	9,5	8,8	10,9	3	6
VT1763-5204	M8x1	OD6	3	5,5	25,5	14,5	11,6	10,9	3	10
VT1763-5402	M10x1	OD4	3	5,5	19,2	9,7	8,8	11,9	3	8
VT1763-5404	M10x1	OD6	5	5,5	24,8	14,8	11,6	11,9	5,5	10
VT1763-5406	M10x1	OD8	6	5,5	28	-	14,8	13	6	15

## Straight screw-in connector with female thread

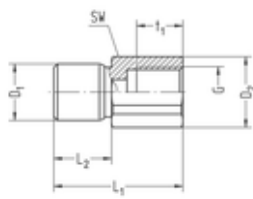

- Whitworth pipe thread
- Seals FPM
- Material AISI 304/ 304L (1.4301 / 1.4307)
- Temperature range -4 to 248 °F (-20 to +120 °C)
- Working pressure range -14 to 348 psi (-0.95 to 24 bar)

Part no.	G	for tube	SW	L1	L2	t1	D1	D2	NW	g/piece
VT1717-0104	G1/8	OD6	14	29,5	15	8	11,5	15,2	4	20

## Elbow screw-in connector, swiveling

- Whitworth pipe thread
- Chambered O-ring
- Seals FPM
- Material AISI 304/ 304L (1.4301 / 1.4307)
- Temperature range -4 to 248 °F (-20 to +120 °C)
- Working pressure range -14 to 348 psi (-0.95 to 24 bar)
- Not designed for steady motion of the tube

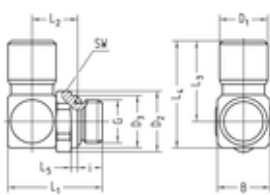

Part no.	G	for tube	SW	i	L1	L2	L3	L4	B	D1	D2	D3	NW	g/piece
VT1786-0202	G1/8	OD4	13	7	22,9	10,9	18,5	23	10	8,8	14,2	0	2,5	14
VT1786-0204	G1/8	OD6	13	7	25,4	11,4	23,5	29,5	14	11,6	14,2	0	4	22
VT1786-0206	G1/8	OD8	13	7	29,4	14,4	27,5	35	16	14,8	14,2	0	5,5	41
VT1786-0208	G1/8	OD10	17	7	31,4	15,4	31,5	40,5	18	16,8	18,5	14,9	5,5	59
VT1786-0209	G1/8	OD12	17	7	34	17	37	47	20	20,1	18,5	14,9	5,5	84
VT1786-0402	G1/4	OD4	17	9	25,4	11,4	18,5	23	10	8,8	18,5	0	2,7	25
VT1786-0404	G1/4	OD6	17	9	29,4	13,4	23,5	29,5	14	11,6	18,5	0	4	38
VT1786-0406	G1/4	OD8	17	9	31,9	14,9	27,5	35	16	14,8	18,5	0	6,5	49
VT1786-0408	G1/4	OD10	17	9	33,9	15,9	31,5	40,5	18	16,8	18,5	0	8	61
VT1786-0409	G1/4	OD12	17	9	36,4	17,4	37,3	47,3	20	20,1	18,5	0	9	83
VT1786-0604	G3/8	OD6	22	9	29,4	13,4	23,5	29,5	14	11,6	23,8	0	4	49
VT1786-0606	G3/8	OD8	22	7,5	30,4	14,9	27,5	35	16	14,8	23,8	0	6,5	59
VT1786-0608	G3/8	OD10	22	9	34,4	16,4	31,5	40,5	18	16,8	23,8	0	8	75
VT1786-0609	G3/8	OD12	22	9	36,9	17,9	37,3	47,3	20	20,1	23,8	0	9	96
VT1786-0804	G1/2	OD6	24	9,5	29,3	14,2	22,5	28,5	12	11,6	26,2	24	4	51
VT1786-0806	G1/2	OD8	24	9,5	33,9	16,4	27,5	35	16	14,8	26,2	0	6	78
VT1786-0808	G1/2	OD10	24	9,5	33,7	15,9	31	40	18	16,8	26,2	24	8	78
VT1786-0809	G1/2	OD12	24	9,5	36	17	38	48,5	21	20,1	26,2	24	9	103
VT1786-0812	G1/2	OD16	24	11	43,5	20,5	47,5	59,5	24	25,1	26,2	0	12	161

17A

## Elbow screw-in connector, swiveling

- Metric thread
- Chambered O-ring
- Seals FPM
- Material AISI 304/ 304L (1.4301 / 1.4307)
- Temperature range -4 to 248 °F (-20 to +120 °C)
- Working pressure range -14 to 348 psi (-0.95 to 24 bar)
- Not designed for steady motion of the tube

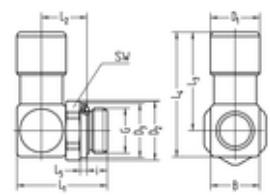

Part no.	G	for tube	SW	i	L1	L2	L3	L4	B	D1	D2	D3	NW	g/piece
VT1787-4602	M6	OD4	12	5	18,9	8,9	18,5	23	10	8,8	-	0	4	12
VT1787-4802	M7	OD4	10	5	17,7	8,4	17,5	21,5	8,5	8,8	-	0	2	11
VT1787-4804	M7	OD6	10	5	24,4	11,4	23,5	29,5	14	11,6	-	0	4	26
VT1787-5002	M5	OD4	8	4,5	18,4	8,9	18,5	23	10	8,8	-	0	2,5	11
VT1787-5004	M5	OD6	8	4,5	20,4	9,9	21,5	26	11	11,6	-	0	2,5	16
VT1787-5202	M8x1	OD4	11	7	20,9	8,9	18,5	23	10	8,8	-	0	4	13
VT1787-5204	M8x1	OD6	11	7	25,4	11,4	23,5	29,5	14	11,6	-	0	4	26
VT1787-5402	M10x1	OD4	13	7	20,9	8,9	17,5	21,5	10	8,8	-	0	4	16
VT1787-5404	M10x1	OD6	13	7	26,9	13,2	23,5	29,5	14	11,6	-	0	5,5	30
VT1787-5406	M10x1	OD8	13	7	29,4	14,4	27,5	35	16	14,8	-	0	5,5	43
VT1787-5406X	M10x1	OD8	13	5,5	27,9	14,4	27,5	35	16	14,8	-	0	5,5	43

## Elbow screw-in connector, swiveling

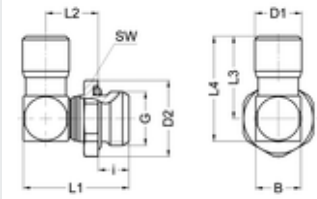

- Whitworth pipe thread
- Chambered O-ring
- Seals FPM
- Material AISI 304/ 304L (1.4301 / 1.4307)
- Temperature range -4 to 248 °F (-20 to +120 °C)
- Working pressure range -14 to 348 psi (-0.95 to 24 bar)
- Not designed for steady motion of the tube

17A

Part no.	G	for tube	SW	i	L1	L2	L3	L4	B	D1	D2	NW	g/piece
VT1704-0404	G1/4	OD6	17	7,5	27	14	22	27,5	11	11,6	18,5	4,5	29
VT1704-0604	G3/8	OD6	17	7,5	27	14	22	27,5	11	11,6	21,8	4,5	31

## Double connector

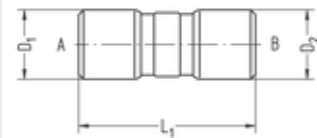

- Seals FPM
- Material AISI 304/ 304L (1.4301 / 1.4307)
- Temperature range -4 to 248 °F (-20 to +120 °C)
- Working pressure range -14 to 348 psi (-0.95 to 24 bar)

Part no.	for tube A	for tube B	L1	D1	D2	NW	g/piece
VT1733-0202	OD4	OD4	29	8,8	8,8	2,5	9
VT1733-0404	OD6	OD6	35	11,6	11,6	4	15
VT1733-0606	OD8	OD8	41,5	14,8	14,8	6	29
VT1733-0808	OD10	OD10	48	16,8	16,8	8	40
VT1733-0909	OD12	OD12	58	20,1	20,1	9	67

## Elbow connector

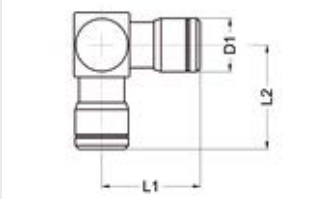

- Seals FPM
- Material AISI 304/ 304L (1.4301 / 1.4307)
- Temperature range -4 to 248 °F (-20 to +120 °C)
- Working pressure range -14 to 348 psi (-0.95 to 24 bar)

Part no.	for tube	L1	L2	D1	NW	g/piece
VT1777-0200	OD4	18	17,5	8,8	2,5	16
VT1777-0400	OD6	22	23	11,6	4	26
VT1777-0600	OD8	26,5	27,5	14,8	6	48
VT1777-0800	OD10	30,5	32	16,8	8	65
VT1777-0900	OD12	36,5	37	20,1	9	107

## T-connector

- Seals FPM
- Material AISI 304/ 304L (1.4301 / 1.4307)
- Temperature range -4 to 248 °F (-20 to +120 °C)
- Working pressure range -14 to 348 psi (-0.95 to 24 bar)

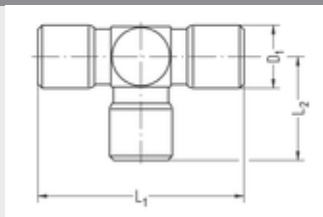

Part no.	for tube	L1	L2	D1	NW	g/piece
VT1778-0200	OD4	36	17,5	8,8	2,5	18
VT1778-0400	OD6	44	23	11,6	4	33
VT1778-0600	OD8	53	27,5	14,8	6	59
VT1778-0800	OD10	61	32	16,8	8	82
VT1778-0900	OD12	74	36,5	20,1	9	132

## Y-plug, swiveling

- Whitworth pipe thread
- Chambered O-ring
- Seals FPM
- Material AISI 304/ 304L (1.4301 / 1.4307)
- Temperature range -4 to 248 °F (-20 to +120 °C)
- Working pressure range -14 to 348 psi (-0.95 to 24 bar)
- Not designed for steady motion of the tube

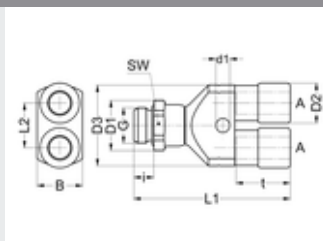

Part no.	G	for tube A	SW	i	L1	L2	D1	D2	B	d1	NW	g/piece
VT1772-0404	G1/4	OD6	17	7,5	51	14	18,5	11,6	8,5	5,1	4	56

## Bulkhead connector

- Seals FPM
- Material AISI 304/ 304L (1.4301 / 1.4307)
- Temperature range -4 to 248 °F (-20 to +120 °C)
- Working pressure range -14 to 348 psi (-0.95 to 24 bar)

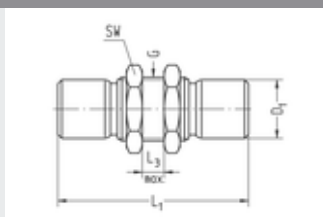

Part no.	for tube	G	SW	L1	L3 max.	D1	NW	g/piece
VT1780-0202	OD4	M12x1	14	33	6	8,8	2,5	20
VT1780-0404	OD6	M14x1	17	42	8	11,6	4	36
VT1780-0606	OD8	M16x1	19	48	8	14,8	6	51
VT1780-0808	OD10	M18x1	22	57	10	16,8	8	78
VT1780-0909	OD12	M22x1	27	61	12	20,1	9	119

## Bulkhead connector with female thread

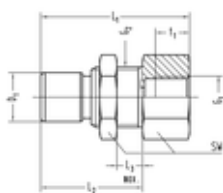

- Whitworth pipe thread
- Seals FPM
- Material AISI 304/ 304L (1.4301 / 1.4307)
- Temperature range -4 to 248 °F (-20 to +120 °C)
- Working pressure range -14 to 348 psi (-0.95 to 24 bar)

17A

Part no.	G1	for tube	G2	SW	L1	L2	L3 max.	D1	t1	NW	g/piece
VT1702-0102	G1/8	OD4	M12x1	14	29	18,5	6	8,8	8	2,5	20

## Reducing plug

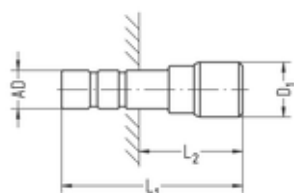

- FPM seals
- Material AISI 304/ 304L (1.4301 / 1.4307)
- Temperature range -4 to 248 °F (-20 to +120 °C)
- Working pressure range -14 to 348 psi (-0.95 to 24 bar)
- Fits all connections in program 17 and 17A in the respective size

Part no.	plug AD	for tube	L1	L2	D1	NW	g/piece
VT1721-0402	6	OD4	32	15,5	8,8	2,5	5
VT1721-0602	8	OD4	33,5	15,5	8,8	2,5	7
VT1721-0604	8	OD6	38	20	11,6	4	12



## Screw joints

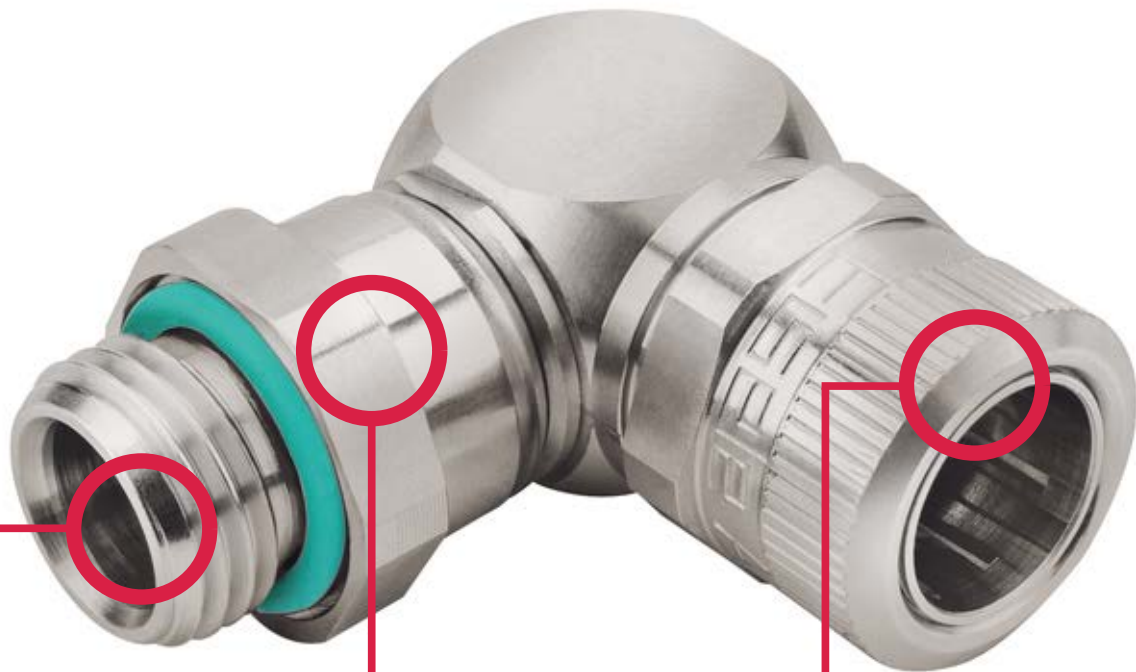

Screw joint

### Media resistant materials

- For applications in the food industry
- Highest material quality - use of stainless and acid-resistant steel  
AISI 304/ 304L/ 316 (L1.4301 / 1.4307 / 1.4404)

### Handlings-efficiency

- Fast and safe assembly and disassembly of the hoses

### With patented union nut

- Secure connection even with hose movement and vibration of the machine
- Easy cleaning of the connections

Also suitable for vacuum applications.

## Screw-in connector

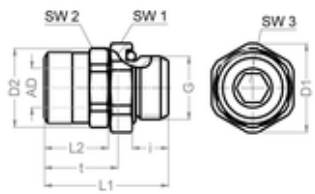

- Whitworth pipe thread DIN ISO 228
- Chamfered O-ring
- Seals FPM
- Material: 1.4404
- Temperature range: -4 to 248 °F (-20 to +120 °C)
- Working pressure range: -14 to 232 psi (-0.95 to 16 bar)

Part no.	G	for tube	SW1	SW2	SW3	i	L1	L2	D1	D2	t	NW	g/piece
VT4528-0202	G1/8	OD4	13	10	3	5,5	22	11,6	14,2	11,2	13	3	2
VT4528-0204	G1/8	OD6	13	12	4	5,5	23,8	13	14,2	13,1	15	4,5	2
VT4528-0206	G1/8	OD8	14	15	5	5,5	25,5	15	15,2	16,4	17	5,5	4
VT4528-0402	G1/4	OD4	17	10	3	7,5	24,3	11,8	18,5	11,2	13	3	2
VT4528-0404	G1/4	OD6	17	12	4	7,5	25,8	13	18,5	13,1	15	4,5	3
VT4528-0406	G1/4	OD8	17	15	6	7,5	27,5	15	18,5	16,4	17	6,5	5
VT4528-0408	G1/4	OD10	17	17	8	7,5	28,8	15	18,5	18,5	18	8,5	7
VT4528-0409	G1/4	OD12	20	22	8	7,5	32	16,5	21,8	23,5	20	8,5	9
VT4528-0606	G3/8	OD8	20	15	6	7,5	27,5	15	21,8	16,4	17	6,5	6
VT4528-0608	G3/8	OD10	20	17	8	7,5	28	15	21,8	18,5	18	8,5	7
VT4528-0609	G3/8	OD12	22	22	8	7,5	32	16,5	23,8	23,5	20	8,5	10
VT4528-0611	G3/8	OD14	22	24	10	7,5	33,2	17,7	23,8	25,5	21,7	10,5	11
VT4528-0808	G1/2	OD10	24	17	8	9,5	31	15	26,2	18,5	18	8,5	7
VT4528-0809	G1/2	OD12	24	22	10	9,5	32	16,5	26,2	23,5	20	10,5	11
VT4528-0811	G1/2	OD14	24	24	12	9,5	33,2	17,7	26,2	25,5	21,7	12,5	12
VT4528-0812	G1/2	OD16	27	27	13	9,5	42,3	22,8	29,8	29,8	30	13,5	18
VT4528-0815	G1/2	OD20	30	32	14	9,5	42,3	22,8	33,5	35	30	14,5	22

## Elbow screw-in connector, swiveling

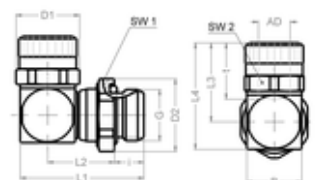

- Whitworth pipe thread DIN ISO 228
- Chamfered O-ring
- Seals FPM
- Material: 1.4404
- Temperature range: -4 to 248 °F (-20 to +120 °C)
- Working pressure range: -14 to 232 psi (-0.95 to 16 bar)
- Not designed for steady motion of the tube

Part no.	G	for tube	SW1	SW2	i	L1	L2	L3	L4	D1	D2	t	B	NW	g/piece
VT4504-0202	G1/8	OD4	13	10	5,5	23	13	17	21	11,2	14,2	13	9	3	5
VT4504-0204	G1/8	OD6	14	12	5,5	26	15	20	25	13,1	14,2	15	11	4,5	6
VT4504-0206	G1/8	OD8	14	15	5,5	31,5	19	23	30	16,4	15,2	17	14	5,5	10
VT4504-0402	G1/4	OD4	17	10	7,5	25	13	17	21	11,2	18,5	13	9	3	16
VT4504-0404	G1/4	OD6	17	12	7,5	27	14	20	25	13,1	18,5	15	11	4,5	16
VT4504-0406	G1/4	OD8	17	15	7,5	31,5	17	23	30	16,4	18,5	17	14	6,5	17
VT4504-0408	G1/4	OD10	17	17	7,5	36,3	20,8	25	33	18,5	18,5	18	16	8,5	18
VT4504-0604	G3/8	OD6	20	12	7,5	27	14	20	25	13,1	21,8	15	11	4,5	11
VT4504-0606	G3/8	OD8	20	15	7,5	30	15,5	23	30	16,5,4	21,8	17	14	6,5	16
VT4504-0608	G3/8	OD10	20	17	7,5	33,3	17,8	25	33	18,5	21,8	18	16	8,5	20
VT4504-0609	G3/8	OD12	20	22	7,5	41,3	23,3	29	39,5	23,5	21,8	20	21	9	34
VT4504-0611	G3/8	OD14	20	24	7,5	43,5	25	31,5	43,1	25,5	21,8	21,7	22	11	38
VT4504-0808	G1/2	OD10	24	17	9,5	35,8	18,3	25	33	18,5	26,2	18	16	8,5	25
VT4504-0809	G1/2	OD12	24	22	9,5	40,8	20,8	29	39,5	23,5	26,2	20	21	9	39
VT4504-0811	G1/2	OD14	24	24	9,5	42,5	22	31,5	43,1	25,5	26,2	21,7	22	11	42
VT4504-0812	G1/2	OD16	24	27	9,5	47,5	26	53	41	29,8	26,2	30	24	12,5	65
VT4504-0815	G1/2	OD20	24	32	9,5	60,8	36,3	42,5	56	35	25,8	30	30	13,5	87

## Swivel joint

- Whitworth pipe thread DIN ISO 228
- Chambered O-ring
- Seals FPM
- Material 1.4404
- Temperature range -20 to +120 °C
- Working pressure range -0.95 to 16 bar

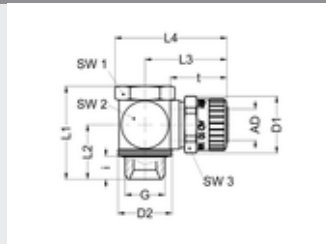

Part no.	G	for tube	SW	i	L1	L2	L3	L4	B	D1	D2	NW	g/piece
SA1699-0408	G1/4	OD10	17	7,5	30,2	17,7	27	35	17	17,7	18,5	7,5	57

## Straight male stud coupling

- Whitworth pipe thread DIN ISO 228
- Chambered O-ring
- Seals FPM
- Material: AISI 316L (1.4404)
- Temperature range -4 to 248 °F (-20 to +120 °C)
- Working pressure range -14 to 232 psi (-0.95 to 16 bar)

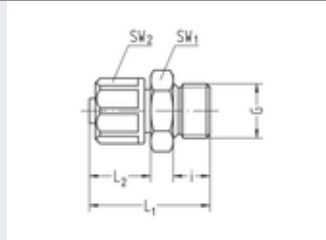

Part no.	G	for tube	SW1	SW2	i	L1	L2	NW	g/piece
VT28-0204GSW4	G1/8	6/4	14	13	6,5	24	13	3,1	14
VT28-0208GSW4	G1/8	10/8	14	16	6,5	27	16	5,5	20
VT28-0604GSW4	G3/8	6/4	19	13	9	28	13	3,1	36
VT28-0608GSW4	G3/8	10/8	19	16	9	31	16	6,6	39

## Straight male stud coupling

- For compressed-air hoses made of PVC with fabric lining
- Whitworth pipe thread DIN ISO 228
- Material AISI 303 (1.4305) / POM
- Temperature range 14 to 140 °F (-10 to +60 °C)
- Working pressure range -14 to 145 psi (-0.95 to 10 bar)

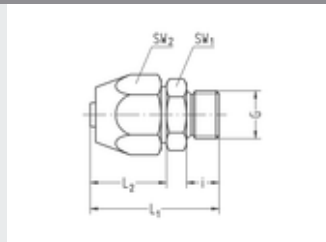

Part no.	G	for tube	SW1	SW2	i	L1	L2	NW	g/piece
68-0813W5	G1/2	20 / 13	27	30	11	43	25	11	139
68-1019W5	G3/4	26 / 19	36	41	14	55	33	15	308

Screw joint



## Connectors for connections dead zone-free

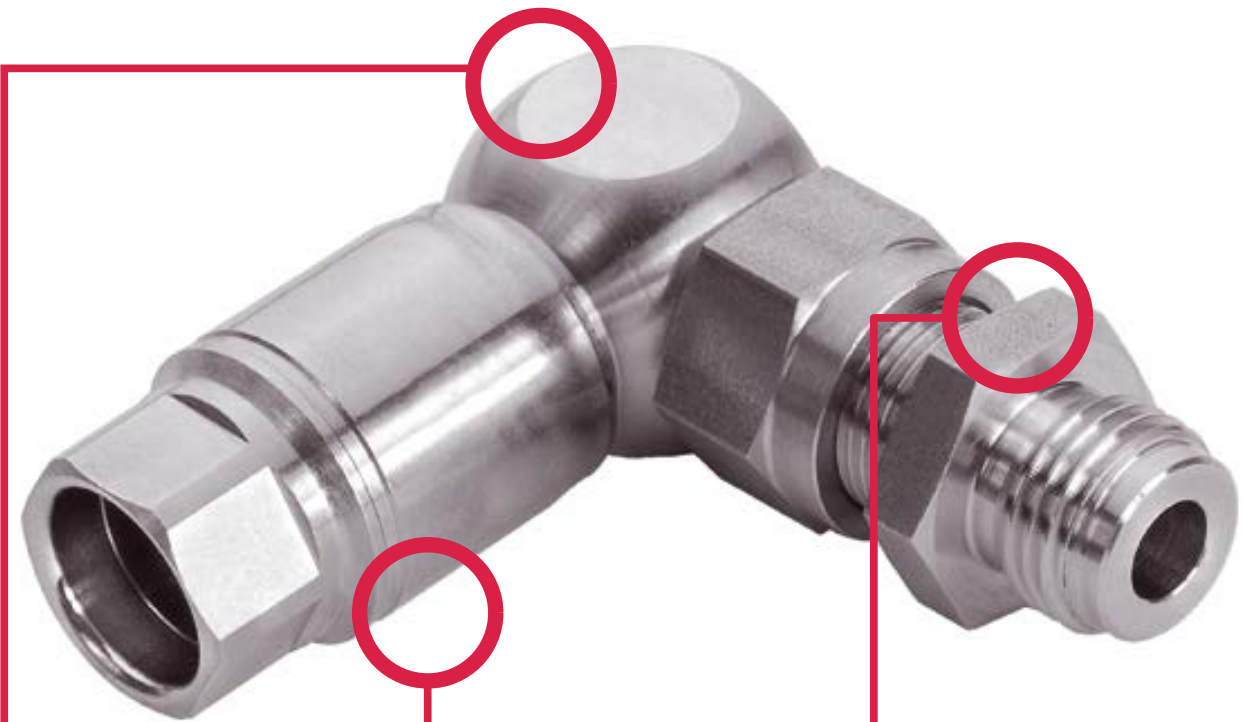

Patent-registered and  
innovativ

- For applications free of dead zones, where no accumulation of the system is allowed

Flexible and  
safe in handling

- With the combined plug-screw-mounting the hose-fitting connection could be mounted by only one rotation of the union nut
- Unintentional opening of the union nut is not possible

Versatile and  
quick applicable

- Quick, economic assembly and disassembly; low system costs
- Tube conditioning possible on-site. Tubes don't have to be pre-fabricated

Series 1600 is also available as a version completely made of stainless steel. Feel free to ask for information about our series 3600.

1600

## Functional principle

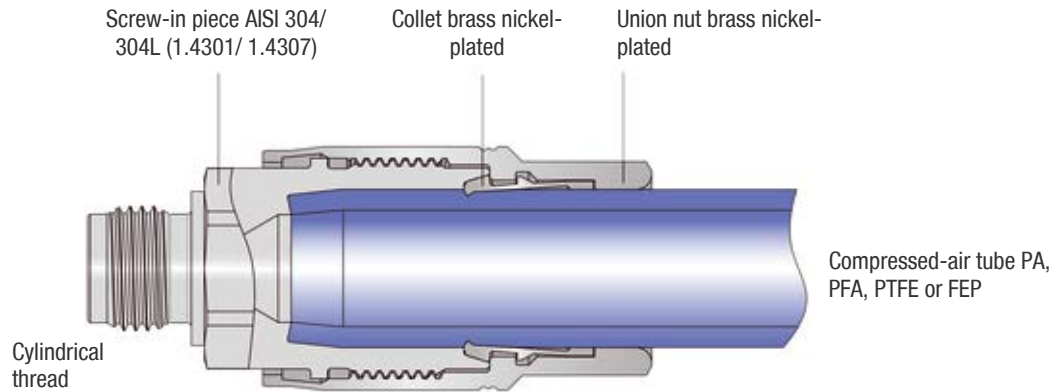

## 1600

### Advantages

- Patent-registered solution free of dead zones
- No gaps for accumulation
- Internal sterilization possible
- Simple internal cleaning
- Quick changes of the medium possible
- Simple and safe sealing concept
- No necessity of an additional sealing, no compatibility problems
- Well-engineered connection system
- Small sizes available

### Additional options

- Complete stainless-steel version for corrosive areas
- Other materials
- Thread designs to your requirements (on request)
- Integrated valves, e.g. with check valve or throttle function
- Patent registered color coding

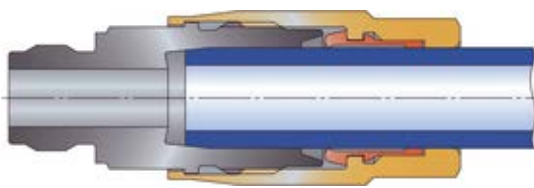

Tube, disconnected

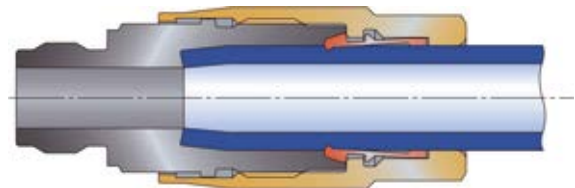

Tube, connected

## Service conditions

- Working pressure range: 0 to 362 psi (0 to 25 bar)
- Temperature range: 32 to 176 °F (0 to +80°C)
- No gaps where accumulation is possible
- Full through flow
- Material with media contact: AISI 304/ 304L (1.4301/ 1.4307)
- Suitable for tubes made of PA, PTFE and FEP; other materials on request
- Simple and safe sealing concept
- No necessity of an additional sealing, no compatibility problems
- Well-engineered connection system
- Small sizes available



## Tubes

Tube dimension		PA Temperature range -76 to 212 °F (-60 to +100°C)		PTFE Temperature range -310 to 500 °F (-190 to +260°C)		FEP Temperature range -31 to +248 °F (-35 to +120°C)		PFA Temperature range -4 to 302 °F (-20 to +150°C)	
Outside-Ø	Inside-Ø	R min.	Burst pressure 68 °F (20°C)	R min.	Burst pressure 68 °F (20°C)	R min.	Burst pressure 68 °F (20°C)	R min.	Burst pressure 68 °F (20°C)
5 (+0,1/-0,1)	3	25	1624 psi (112 bar)	25	870 psi (60 bar)	35	754 psi (52 bar)	-	-
6 (+0,1/-0,1)	4	30	1290 psi (89 bar)	35	696 psi (48 bar)	40	580 psi (40 bar)	12	870 psi (60 bar)
9 (+0,1/-0,1)	6	45	1290 psi (89 bar)	55	696 psi (48 bar)	-	-	-	-
12 (+0,15/-0,1)	9	60	914 psi (63 bar)	100	580 psi (40 bar)	-	-	29	725 psi (50 bar)

The mounted tubes are not to be exposed to tensile loading.

Important notes for the use of tubes made of PA, PFA, PTFE and FEP:

- The outside diameter of tubes must be free of grooves and other damages (e.g. damage from installation tools).
- Prior to assembly, use the Eisele tube cutter Art. No. 99605-0014 or Art. No. 99606-0022 to cut tubes at a right angle. Ensure that tubes are not being deformed or damaged during the cutting process.
- Afterwards the tube must be finished regarding the Eisele mounting instruction.

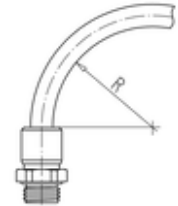

1600

## Connection thread

Thread	Core hole-Ø K (mm)	Thread counterbore		ØD1 (mm)	Torque max. (Nm)	Seal ring	Thread standards
		t1 min. (mm)	t2 min. (mm)				
G1/8	8,7 (±0,1)	9,7 (+0,1)	8,5 (+0,5)	5	12	3615-02	Pipe thread G: DIN ISO 228
G1/4	11,75 (±0,1)	11,7 (+0,1)	10,5 (+0,5)	8	12	1615-04	
G3/8	15,2 (±0,1)	13,7 (+0,1)	12 (+0,5)	10	12	3615-06	

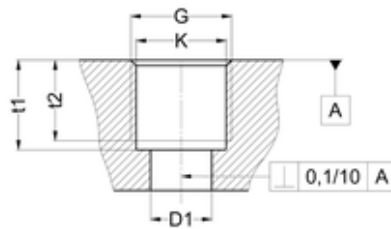

## Handling

Assembly regarding Eisele mounting instruction

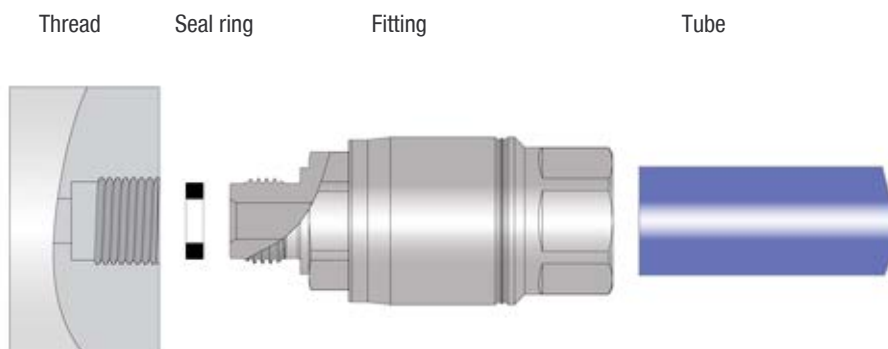

## Assembly instructions

Designation	Article number
Screw-in plug connector	1628-XXXXXX
Elbow-screw-in plug connector, lockable	1661-XXXXXX
Elbow-screw-in plug connector 45°, lockable	1663-XXXXXX
L-screw-in plug connector, lockable	1658-XXXXXX
T-screw-in plug connector, lockable	1662-XXXXXX
Y-screw-in plug connector, lockable	1619-XXXXXX
Bulkhead plug connector, hose/hose, two-piece	1680-XXXXXX
Bulkhead plug connector, hose/pipe	1694-XXXXXX
Elbow-bulkhead plug connector, hose/hose, two-piece	1614-XXXXXX
Elbow-bulkhead plug connector, hose/pipe, two-piece	1615-XXXXXX and 1616-XXXXXX

### 1. Screw in threaded plug connection

Remove the plug from the threaded connection, if necessary.

Check whether the seal ring (inner-sealing) is inserted.

The threads can be coated with Loctite 542 all the way around to prevent damage to the threads and to increase the torque (counter-clockwise rotation/loosening of hose).

Screw in the plug connection using a strengthened 4 mm Allen key or corresponding open-end spanner insert and tighten to 12 Nm. Watch out for the direction of the arrow on the torque wrench.

### 2. Mounting of the bulkhead and angled bulkhead plug connections

Unscrew one connection side (size 17, 19 or 22). Unscrew hexagon (size 17 or 22). Insert threaded bolt in bulkhead plate hole. Screw on hexagon nut and tighten firmly, while counter-holding with a wrench. Screw in connection side and tighten cap nut to 25 Nm, while counter-holding with a wrench.

### 3. Preparation of the hose for mounting

Cut hose to length using hose cutter 99606-0022. Fasten a suitable hose processing tool (e.g. for hose 5/3 – WZ660-03) in a drill or cordless screwdriver. Use a rotating hose processing tool, applying slight pressure, to remove material from hose end to produce a clean face area perpendicular to the hose axis (use a speed of about 300 rpm).

Remove hose processing tool and visually check hose for impurities and blow out, if necessary. Take into account that the hose length will be shortened during this process.

### 4. Marking the insertion depth

Push the processed hose end all the way into the matching sleeve for hose marking (e.g. for hose 5/3 – WZ688-05). Mark the insertion depth on the hose using a felt-tipped pen.

The insertion depth does not always have to be marked. It is used to get a feel for the required hose insertion depth during final assembly.

### 5. Mounting the hose

Loosen the threaded sleeve on the hose connection  $\frac{3}{4}$  of a revolution until you feel the stop. Insert hose past the pressure point firmly onto the base of the hose connection. The front face must be pushed all the way to the stop, since the end serves as the sealing surface. Watch out for the insertion depth, if applicable.

Tighten threaded sleeve using a suitable socket wrench or box-end wrench insert with a torque wrench to 8 Nm.

### 6. Removing the hose

Use a suitable socket wrench, box-end wrench insert or box-end wrench to loosen the threaded sleeve  $\frac{3}{4}$  of a revolution (counter-clockwise) until you feel the stop. Use an open-end wrench to counter-hold the hose connection, if necessary.

Pull out the hose.

**Important:** A hose end that was already connected cannot be reconnected! The hose must be processed again!

### 7. Replacement of the plug connection

Remove hose (see no. 5).  
 Unscrew the plug-in connection.  
 Eliminate any impurities.  
 Insert new seal ring (inner-sealing).  
 Hose must be re-processed (see no. 3).  
 Continue assembly (see no. 4 and 5).

### 8. Tightening torque of cap nut

For all two-part plug connections, such as

Designation	Article number
Elbow-screw-in plug connector, lockable	1661-XXXXXX
Elbow-screw-in plug connector 45°, lockable	1663-XXXXXX
L-screw-in plug connector, lockable	1658-XXXXXX
T-screw-in plug connector, lockable	1662-XXXXXX
Y-screw-in plug connector, lockable	1619-XXXXXX
Bulkhead plug connector, hose/hose, two-piece	1680-XXXXXX
Elbow-bulkhead plug connector, hose/hose, two-piece	1614-XXXXXX
Elbow-bulkhead plug connector, hose/pipe, two-piece	1615-XXXXXX and 1616-XXXXXX

the cap nut size 17 must be tightened to 25 Nm.

Example of the torques on a connection for a hose 12/9:



1661-040900

1600

## Threaded connectors

starting on page 39



Straight threaded connectors

page 39



Angled threaded connectors

page 39



T-connectors

page 40



Y-connectors

page 41



Bulkhead connectors

page 41

## Accessories

starting on page 43

## Screw-in plug connector

- Whitworth pipe thread
- **Frame components with media contact:**  
Material stainless steel AISI 304/ 304L (1.4301/1.4307)
- **Frame components without media contact:**  
Material brass chemically nickel-plated
- Temperature range 32 to 176 °F (0 to +80 °C)
- Working pressure range 0 to 362 psi (0 to 25 bar)

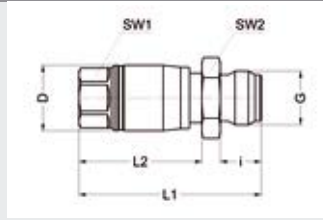

Part no.	G	for tube	SW1	SW2	i	L1	L2	D	NW	g/piece
1628-020300	G1/8	OD5 (5/3)	11	14	8	38	ca. 23,5	12,4	2,3	27
1628-020400	G1/8	OD6 (6/4)	11	14	8	38	ca. 23,5	12,9	3,3	25
1628-020500	G1/8	AD8 (8/5)	13	17	8	43	ca. 27	15,9	4,2	39
1628-020600	G1/8	OD 9 (9/6)	13	12	8	40	ca. 27	15,9	4,2	31
1628-020900	G1/8	OD12 (12/9)	15	14	8	44	ca. 30	18,8	4,2	40
1628-040300	G1/4	OD5 (5/3)	11	17	10	39,5	ca. 25	12,4	2,3	32
1628-040400	G1/4	OD6 (6/4)	11	17	10	39,5	ca. 25	12,9	3,3	32
1628-040500	G1/4	AD8 (8/5)	13	17	10	44,5	ca. 30	15,9	4,2	44
1628-040600	G1/4	OD 9 (9/6)	13	17	10	44,5	ca. 30	15,9	5,2	41
1628-040900	G1/4	OD12 (12/9)	15	17	10	47,5	ca. 33	18,8	6	49
1628-060500	G3/8	AD8 (8/5)	13	19	12	47	ca. 30	15,9	4,2	51
1628-060600	G3/8	OD 9 (9/6)	13	19	12	47	ca. 30	15,9	5,2	53
1628-060900	G3/8	OD12 (12/9)	15	19	12	50	ca. 33	18,8	8,2	57

1600

## Elbow-screw-in plug connector, lockable

- Whitworth pipe thread
- **Frame components with media contact:**  
Material stainless steel AISI 304/ 304L (1.4301/1.4307)
- **Frame components without media contact:**  
Material brass chemically nickel-plated
- Temperature range 32 to 176 °F (0 to +80 °C)
- Working pressure range 0 to 362 psi (0 to 25 bar)

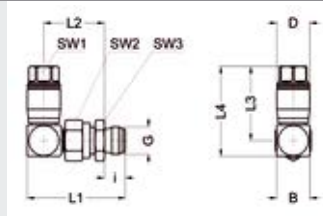

Part no.	G	for tube	SW1	SW2	SW3	i	L1	L2	B	D	NW	g/piece
1661-020400	G1/8	OD6 (6/4)	11	15	14	8	41,1	25,6	14	12,9	3,3	60
1661-020600	G1/8	OD 9 (9/6)	13	15	14	8	42,5	26,5	16	15,9	5	74
1661-020900	G1/8	OD12 (12/9)	15	15	14	8	43,4	26,5	17	18,8	5	83
1661-040400	G1/4	OD6 (6/4)	11	17	17	10	45,8	28,3	14	12,9	5,2	66
1661-040500	G1/4	AD8 (8/5)	13	15	17	10	43,5	25,5	16	15,9	4,2	83
1661-040600	G1/4	OD 9 (9/6)	13	17	17	10	47,2	29,2	16	15,9	5,2	80
1661-040900	G1/4	OD12 (12/9)	15	17	17	10	48	29,5	17	18,8	5,2	89
1661-060600	G3/8	OD 9 (9/6)	13	17	19	12	49,7	29,7	16	15,9	5,2	90
1661-060900	G3/8	OD12 (12/9)	15	17	19	12	50,6	30,1	17	18,8	5,2	99

## Elbow-screw-in plug connector, lockable

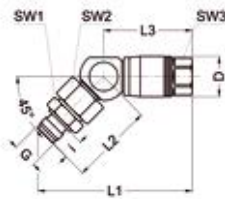

- Whitworth pipe thread
- **Frame components with media contact:**  
Material stainless steel AISI 304/ 304L (1.4301/1.4307)
- **Frame components without media contact:**  
Material brass chemically nickel-plated
- Temperature range 32 to 176 °F (0 to +80 °C)
- Working pressure range 0 to 362 psi (0 to 25 bar)

Part no.	G	for tube	SW1	SW2	i	L1	L2	D	NW	g/piece
1663-020400	G1/8	OD6 (6/4)	14	15	8	58,5	32,5	12,9	5	56
1663-020600	G1/8	OD 9 (9/6)	14	15	8	63	33	15,9	5	67
1663-020900	G1/8	OD12 (12/9)	14	15	8	64	33	18,8	5	44
1663-040500	G1/4	AD8 (8/5)	13	15	10	61	28	15,9	4,2	72

## L-screw-in plug connector, lockable

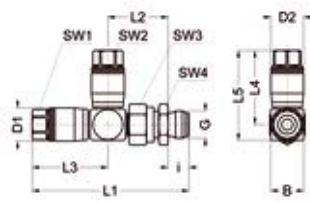

- Whitworth pipe thread
- **Frame components with media contact:**  
Material stainless steel AISI 304/ 304L (1.4301/1.4307)
- **Frame components without media contact:**  
Material brass chemically nickel-plated
- Temperature range 32 to 176 °F (0 to +80 °C)
- Working pressure range 0 to 362 psi (0 to 25 bar)

Part no.	G	for tube A	for tube B	SW1	SW2	i	L1	L2	L3	L4	L5	D1	D2	B	NW	g/piece
1658-020606	G1/8	OD 9 (9/6)	OD 9 (9/6)	13	13	8	74,9	30,2	36,7	35,5	43	15,9	15,9	16	4,2	106
1658-020609	G1/8	OD 9 (9/6)	OD12 (12/9)	15	13	8	77,9	30,2	39,7	35,5	43	15,9	18,8	16	5	113
1658-020909	G1/8	OD 12 (12/9)	OD12 (12/9)	15	15	8	78,7	30,6	40,1	38,5	46	18,8	18,8	17	5	122
1658-040606	G1/4	OD 9 (9/6)	OD 9 (9/6)	13	13	10	75,9	29,2	36,7	35,5	43	15,9	15,9	16	4,2	112
1658-040609	G1/4	OD 9 (9/6)	OD12 (12/9)	15	13	10	78,9	29,2	39,7	35,5	43	15,9	18,8	16	5,2	119
1658-040909	G1/4	OD 12 (12/9)	OD12 (12/9)	15	15	10	79,7	29,6	40,1	38,5	46	18,8	18,8	17	5,2	128

## T-screw-in plug connector, lockable

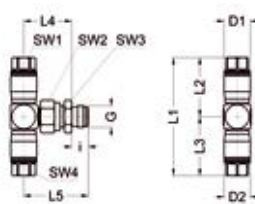

- Whitworth pipe thread
- **Frame components with media contact:**  
Material stainless steel AISI 304/ 304L (1.4301/1.4307)
- **Frame components without media contact:**  
Material brass chemically nickel-plated
- Temperature range 32 to 176 °F (0 to +80 °C)
- Working pressure range 0 to 362 psi (0 to 25 bar)

Part no.	G	for tube A	for pipe B	SW1	SW2	SW3	SW4	L1	L2	L3	L4	L5	D	B	NW	g/piece
1662-020505	G1/8	OD8 (8/5)		13	17	14	13	71	35,5		30,2	38,2			5	105
1662-020606	G1/8	OD 9 (9/6)		13	17	14	13	71	35,5	38,2	30,2	38,2	15,9		5	105
1662-020609	G1/8	OD 9 (9/6)		13	17	14	15	74	35,5	37,6	29,6	37,6	18,8		5	115
1662-020909	G1/8	OD 12 (12/9)		15	17	14	15	77	38,5	38,6	30,6	38,6	18,8		5	122
1662-040606	G1/4	OD 9 (9/6)		13	17	17	13	71	35,5	39,2	29,2	39,2	15,9		5,2	111
1662-040609	G1/4	OD 9 (9/6)		13	17	17	15	74	35,5	39,6	29,6	39,6	18,8		5,2	121
1662-040909	G1/4	OD 12 (12/9)		15	17	17	15	77	38,5	39,6	29,6	39,6	18,8		5,2	128



## Y-screw-in plug connector, lockable

- Whitworth pipe thread
- **Frame components with media contact:**  
Material stainless steel AISI 304/ 304L (1.4301/1.4307)
- **Frame components without media contact:**  
Material brass chemically nickel-plated
- Temperature range 32 to 176 °F (0 to +80 °C)
- Working pressure range 0 to 362 psi (0 to 25 bar)

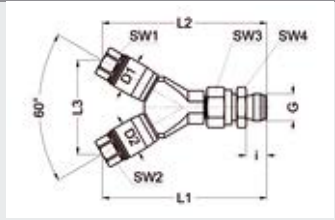

Part no.	G	for tube A	for tube B	SW1	SW2	SW3	SW4	i	L1	L2	L3	D1	D2	NW	g/piece
1619-020606	G1/8	OD 9 (9/6)	OD 9 (9/6)	13	13	17	14	8	79	79	45,5	15,9	15,9	5	135
1619-020609	G1/8	OD 9 (9/6)	OD12 (12/9)	15	13	17	14	8	81,5	79	47	18,8	15,9	5	126
1619-020909	G1/8	OD 12 (12/9)	OD12 (12/9)	15	15	17	14	8	81,5	81,5	48,5	18,8	18,8	5	148
1619-040606	G1/4	OD 9 (9/6)	OD 9 (9/6)	13	13	17	17	10	80	80	45,5	15,9	15,9	5,2	141
1619-040609	G1/4	OD 9 (9/6)	OD12 (12/9)	15	13	17	17	10	82,5	80	47	18,8	15,9	5,2	148
1619-040909	G1/4	OD 12 (12/9)	OD12 (12/9)	15	15	17	17	10	82,5	82,5	48,5	18,8	18,8	5,2	148
1619-060606	G3/8	OD 9 (9/6)	OD 9 (9/6)	13	13	17	19	12	82,5	82,5	45,5	15,9	15,9	5,2	151
1619-060609	G3/8	OD 9 (9/6)	OD12 (12/9)	15	13	17	19	12	85	82,5	47	18,8	15,9	5,2	158
1619-060909	G3/8	OD 12 (12/9)	OD12 (12/9)	15	15	17	19	12	85	85	48,5	18,8	18,8	5,2	164

1600

## Bulkhead plug connector, tube/tube, two-piece

- **Frame components with media contact:**  
Material: Stainless steel AISI 304/ 304L (1.4301/1.4307)
- **Frame components without media contact:**  
Material: Brass chemically nickel-plated
- Temperature range 32 to 176 °F (0 to +80 °C)
- Working pressure range 0 to 362 psi (0 to 25 bar)

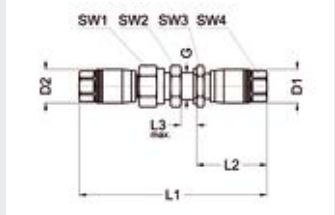

Part no.	for tube A	for tube B	SW1	SW2	SW3	SW4	L1	L2	L3 max.	G	D1	D2	NW	g/piece
1680-000404	OD6 (6/4)	OD6 (6/4)	17	17	17	11	79,5	30	6	M13x1	12,9	12,9	3,3	80
1680-000406	OD6 (6/4)	OD 9 (9/6)	17	17	17	13	84,5	35	6	M13x1	12,9	15,9	3,3	89
1680-000505	OD8 (8/5)	OD8 (8/5)	17	17	17	13	89,5	35	6	M13x1	15,9	15,9	4,2	102
1680-000606	OD 9 (9/6)	OD 9 (9/6)	17	17	17	13	89,5	35	6	M13x1	15,9	15,9	5,2	96
1680-000609	OD 9 (9/6)	OD12 (12/9)	17	17	17	15	92,5	38	6	M13x1	15,9	18,8	5,2	104
1680-000909	OD 12 (12/9)	OD12 (12/9)	19	17	17	15	96	38	6	M13x1	18,8	18,8	6,8	114

## Bulkhead plug connector, tube/pipe

- **Frame components with media contact:**  
Material: Stainless steel AISI 304/ 304L (1.4301/1.4307)
- **Frame components without media contact:**  
Material: Brass chemically nickel-plated
- Temperature range 32 to 176 °F (0 to +80 °C)
- Working pressure range 0 to 362 psi (0 to 25 bar)

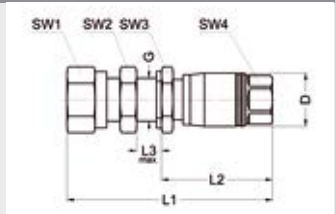

Part no.	for tube A	for pipe B	SW1	SW2	SW3	SW4	L1	L2	L3 max.	G	D	NW	g/piece
1694-000404	OD6 (6/4)	6	14	17	17	11	59,5	ca. 30	6	M13x1	12,9	3,3	60
1694-000607	OD 9 (9/6)	9	17	17	17	13	63	ca. 35	6	M13x1	15,9	5,2	67
1694-000907	OD 12 (12/9)	9	17	17	19	15	66,5	ca. 38	6	M13x1	18,8	7	116
1694-000609	OD 9 (9/6)	12	22	22	22	13	67	ca. 37,5	6	M18x1,5	15,9	5,2	77
1694-000909	OD 12 (12/9)	12	22	22	22	15	70	ca. 39	6	M18x1,5	18,8	8,2	119

## Elbow-bulkhead plug connector, tube/tube, two-piece

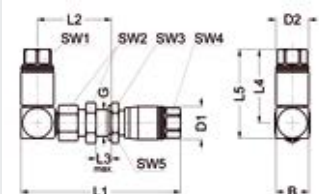

- **Frame components with media contact:**  
Material: Stainless steel AISI 304/ 304L (1.4301/1.4307)
- **Frame components without media contact:**  
Material: Brass chemically nickel-plated
- Temperature range 32 to 176 °F (0 to +80 °C)
- Working pressure range 0 to 362 psi (0 to 25 bar)

Part no.	for tube A	for tube B	SW1	SW2	SW3	SW4	L1	L2	L3	L4	L5	G	D1	D2	B	NW	g/piece
1614-000606	OD 9 (9/6)	OD 9 (9/6)	13	17	17	13	79,2	36,2	6	35,5	43	M13x1	15,9	15,9	16	5	117
1614-000609	OD 9 (9/6)	OD12 (12/9)	13	17	19	15	82,2	36,2	6	35,5	43	M13x1	18,8	15,9	16	5	125
1614-000906	OD 12 (12/9)	OD 9 (9/6)	15	17	17	13	80,1	36,6	6	38,5	46	M13x1	15,9	18,8	17	5,2	126
1614-000909	OD 12 (12/9)	OD12 (12/9)	15	17	19	15	83,1	36,6	6	38,5	46	M13x1	18,8	18,8	17	5,2	134

## Elbow-bulkhead plug connector, tube/pipe, two-piece

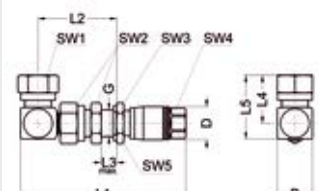

- **Frame components with media contact:**  
Material: Stainless steel AISI 304/ 304L (1.4301/1.4307)
- **Frame components without media contact:**  
Material: Brass chemically nickel-plated
- Temperature range 32 to 176 °F (0 to +80 °C)
- Working pressure range 0 to 362 psi (0 to 25 bar)

Part no.	G	for tube	SW1	SW2	SW3	i	L1	L2	L3	D1	L5	G	D	B	NW	g/piece
1615-000607	M13x1		17	17	17		80,1	36,6	6	30,5	M13x1	15,9	17	5,2	119	
1615-000609	M13x1		22	17	17		81,1	36,6	6	38	M13x1	15,9	19	5,2	149	
1615-000907	M13x1		17	17	19		83,1	36,6	6	30,5	M13x1	18,8	17	5,2	127	
1615-000909	M13x1		22	17	19		84,1	36,6	6	38	M13x1	18,8	19	5,2	157	

## Elbow-bulkhead plug connector, tube/pipe, two-piece

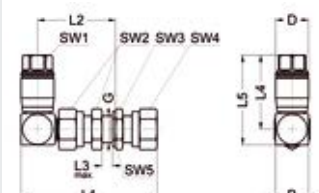

- **Frame components with media contact:**  
Material: Stainless steel AISI 304/ 304L (1.4301/1.4307)
- **Frame components without media contact:**  
Material: Brass chemically nickel-plated
- Temperature range 32 to 176 °F (0 to +80 °C)
- Working pressure range 0 to 362 psi (0 to 25 bar)

Part no.	G	for tube	SW1	SW2	SW3	i	L1	L2	L3	D1	L5	G	D	B	NW	g/piece
1616-000607	M13x1		13	17	17		66	36,2	6	43	M13x1	15,9	16	5,2	113	
1616-000609	M13x1		13	17	22		70	36,2	6	43	M13x1	15,9	16	5,2	144	
1616-000907	M13x1		15	17	17		67	36,6	6	46	M13x1	18,8	17	5,2	123	
1616-000909	M13x1		15	17	22		70,9	36,6	6	46	M13x1	18,8	17	5,2	154	

## Tube sharpener

- Hose sharpener for Series 1600 and 3600



Part no.	for tube	g/piece
WZ660-03	OD5 (5/3)	20
WZ660-04	OD6 (6/4)	21
WZ660-05	AD8 (8/5)	35
WZ660-06	OD 9 (9/6)	41
WZ660-0603	OD6 (6/3)	21
WZ660-09	OD12 (12/9)	56

## Sleeve for hose marking

- Sleeve to mark the hose for Series 1600 and 3600
- To determine how deep the hose must be pushed inside the fitting



Part no.	for tube	g/piece
WZ688-05	OD5 (5/3)	18
WZ688-06	OD6 (6/4)	19
WZ688-09	OD 9 (9/6)	22
WZ688-12	OD12 (12/9)	27

## Tool case

Contents of tool box:

- Torque wrench, standardised (various sizes)
- Plug-in box-end wrench, open (various sizes)
- Square plug-in adapter 3/8
- Handle with sliding element
- Sleeve for hose marking (various sizes)
- Countersink for plastic hose (various sizes)
- Box-end wrench, open (various sizes)
- Hose cutter for compressed air hose
- Socket wrench
- Extension (various sizes)



Part no.	g/piece
WZ660E	4200

1600



## Comfort screw-in connectors for connections without gaps

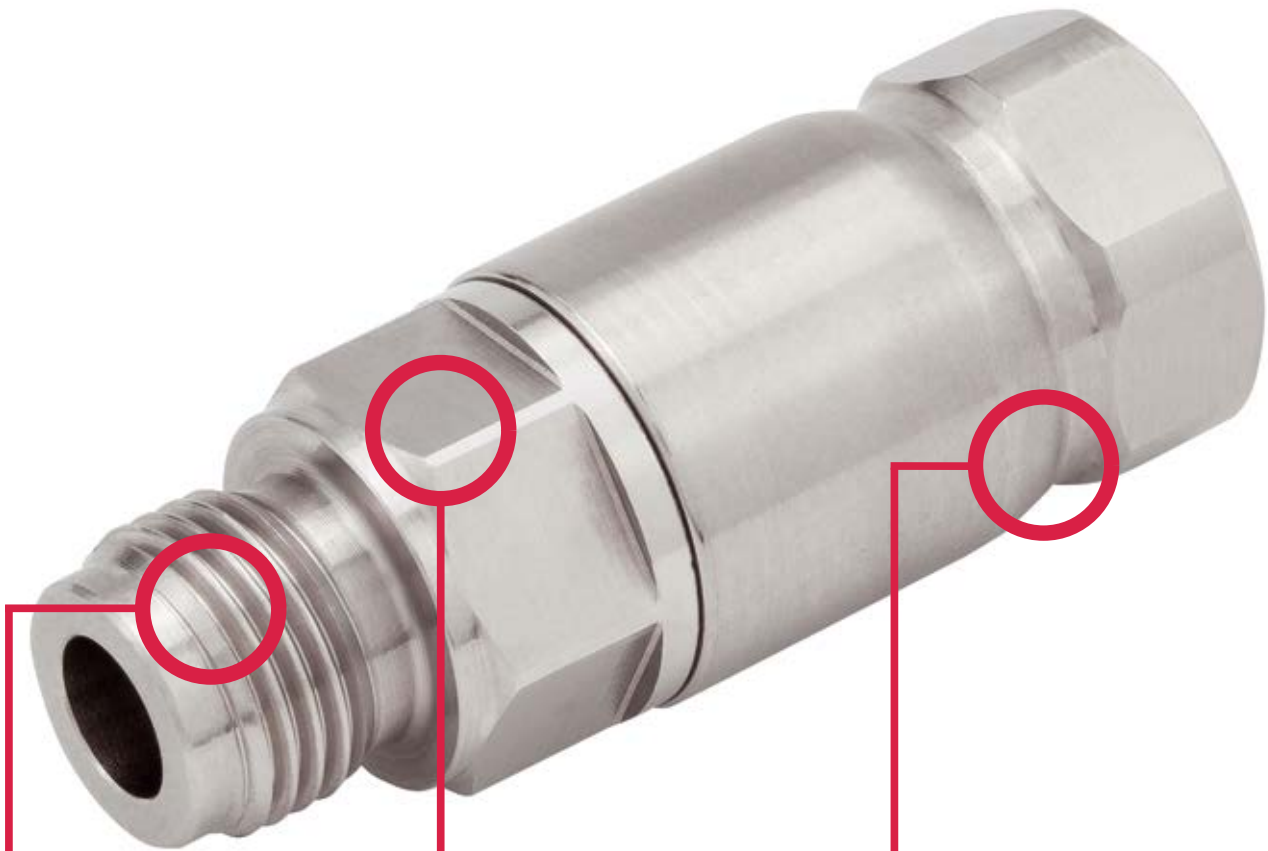

Patent-registered and  
innovativ

- For applications free of dead zones, where hardly none accumulation of the system is allowed

Flexible and  
safe in handling

- With the combined plug-screw-mounting the tube-fitting connection could be mounted by only one rotation of the union nut
- Unintentional opening of the union nut is not possible

Versatile and  
quick applicable

- Quick, economic assembly and disassembly; low system costs
- Quick assembly of the tubes; no additional preparation of the tube

3800

## Functional principle

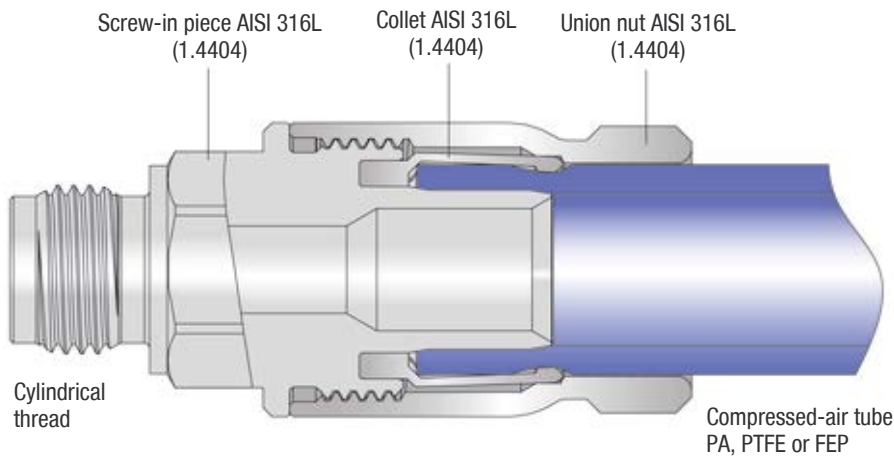

### Advantages

- Patent-registered solution nearly without dead spaces
- No gaps for accumulation
- Internal sterilization possible
- Simple internal cleaning
- Quick changes of the medium possible
- Simple and safe sealing concept
- well-engineered connection system
- small sizes available

### Additional options

- Other materials
- Thread designs to your requirements (on request)
- Integrated valves, e.g. with check valve or throttle function

## Service conditions

- Working pressure range: -14 to 362 psi (-0,95 to 25 bar)
- Temperature range: 32 to 176 °F (0 to +80°C), depending on the tube-material and the pressure
- No gaps where accumulation is possible
- Huge through flow
- Fitting made of stainless steel AISI 316L (1.4404)
- Suitable for tubes made of PE, PA, PTFE and FEP; other materials on request
- Simple and safe sealing concept
- Well-engineered connection system

## Range of application

### Packaging systems

Quick product changes with minimal residue in the system

### Pharmaceutical and medical technology sectors

Sterilization of the system enables high efficiency

### Clean-room technology

Connectors for clean-room technology on request

### Cleaning systems

Cleaning and washing systems with minimal danger of germs

### Lines for food industry

No accumulation in dead spaces; ensures continuously fresh products



## Tubes

Hose dimension		Polyethylene (PE) Temperature range 14 to 104 °F (-10 to +40°C)		Polyamide (PA) Temperature range -76 to 176 °F (-60 to +80°C)		Teflon (PTFE) Temperature range -310 to 500 °F (-190 to +260°C)		PFA Temperature range -4 to 302 °F (-20 to +150°C)	
Outside-Ø	Inside -Ø	R min.	Burst pressure 68°F (20°C)	R min.	Burst pressure 68°F (20°C)	R min.	Burst pressure 68°F (20°C)	R min.	Burst pressure 68°F (20°C)
9 (±0,1)	6 (±0,1)	-	-	45	1290 psi (89 bar)	55	696 psi (48 bar)	-	-
12 (+0,15/-0,1)	9 (±0,15)	75	304 psi (21 bar)	60	914 psi (63 bar)	100	580 psi (40 bar)	29	725 psi (50 bar)

The mounted hoses are not to be exposed to tensile loading.

Important notes for the use of hoses made of PE, PA, FEP, PTFE and PFA:

- The outside diameter of hoses must be free of grooves and other damages (e.g. damage from installation tools).
- Prior to assembly, use the Eisele hose cutter Art. No. 99605-0014 or Art. No. 99606-0022 to cut hoses at a right angle. Ensure that hoses are not being deformed or damaged during the cutting process.

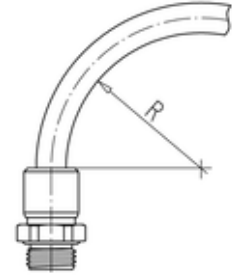

## Connection thread

Thread	Core hole-Ø K (mm)	Thread counterbore		ØD1 (mm)	Torque max. (Nm)	Seal ring	Thread standards
		t1 min. (mm)	t2 min. (mm)				
G1/4	11,75 (±0,1)	11,7 (+0,1)	10,5 (+0,5)	8	12	3615-04	Pipe thread G:
G3/8	15,2 (±0,1)	13,7 (+0,1)	12 (+0,5)	10	12	3615-06	DIN ISO 228

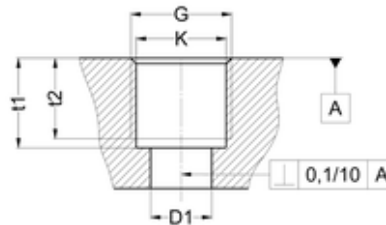

3800

## Handling

Assembly instruction regarding Eisele drawing M3828-...

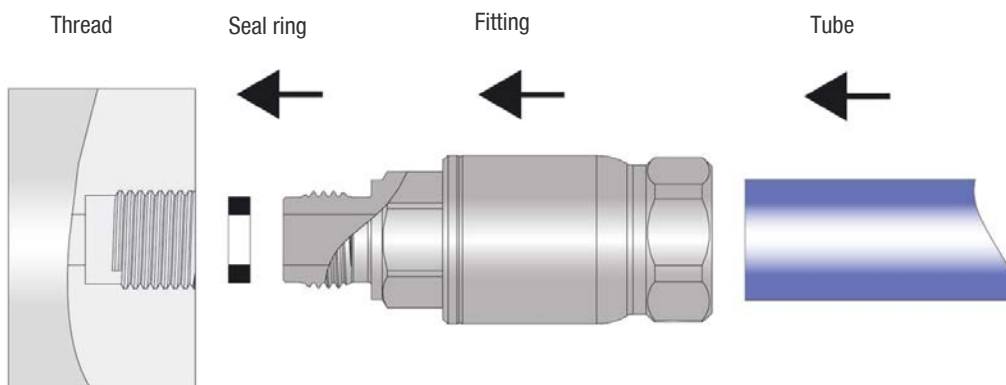

## Threaded connectors

starting on page 49



Straight threaded connectors

page 49



Angled threaded connectors

page 49



Bulkhead connectors

page 49

Accessories series 3800

page 50

3800

## Accessories

starting on page 52

## Screw-in connector

- Whitworth pipe thread
- Material AISI 316L (1.4404)
- Temperature range 32 to 176 °F (0 to +80 °C)
- Working pressure range -14 to 362 psi (-0,95 to 25 bar)
- Specified data depending on the material of the hose
- Assembly instructions M3628-...

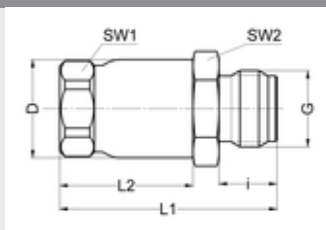

Part no.	G	for tube	SW1	SW2	i	L1	L2	D	NW	g/piece
3828-020600	G1/8	OD 9 (9/6)	13	12	8	37	23	14	5	25
3828-040900	G1/4	OD12 (12/9)	15	17	10	37,5	23	16,8	7	33
3828-060900	G3/8	OD12 (12/9)	15	19	12	40	23	16,8	7	41

## Elbow screw-in connector, lockable

- Whitworth pipe thread
- Material AISI 316L (1.4404)
- Temperature range 32 to 176 °F (0 to +80 °C)
- Working pressure range -14 to 362 psi (-0,95 to 25 bar)
- Specified data depending on the material of the hose
- Assembly instructions M3628-...

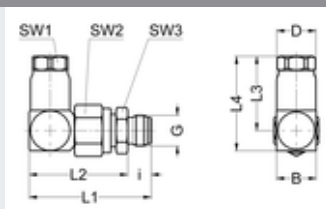

3800

Part no.	G	for tube	SW1	SW2	SW3	i	L1	L2	L3	D1	NW	g/piece
3861-020600	G1/8	OD 9 (9/6)	13	15	14	8	42,5	34,5	29	8	5	65
3861-040900	G1/4	OD12 (12/9)	15	19	17	10	52	33	31,6	10	7	104
3861-060900	G3/8	OD12 (12/9)	15	19	19	12	54,5	33,5	31,6	12	7	116

## Bulkhead connector

- Whitworth pipe thread
- Material AISI 316L (1.4404)
- Temperature range 32 to 176 °F (0 to +80 °C)
- Working pressure range -14 to 362 psi (-0,95 to 25 bar)
- Specified data depending on the material of the hose
- Assembly instructions M3628-...

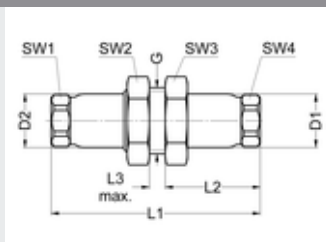

Part no.	for tube A	for tube B	SW1	SW2	SW3	SW4	L1	L2	L3 max.	G	D1	D2	NW	g/piece
3880-000606	OD 9 (9/6)	OD 9 (9/6)	13	19	19	13	59	27	6	M16x1,5	14	14	5	67
3880-000909	OD 12 (12/9)	OD12 (12/9)	15	24	24	15	66	30	6	G1/2	16,8	16,8	7	110

## Seal ring

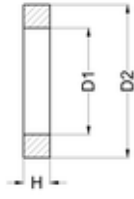

- For Whitworth pipe thread
- Material PTFE
- Temperature range 32 to 176 °F (0 to +80 °C)
- Working pressure range 0 to 362 psi (0 to 25 bar)

Part no.	for thread	D1	D2	H	g/piece
1615-04	G1/4	6,6	11,5	2,2	0,20
3615-02	G1/8	5,5	8,5	2,2	0,10
3615-04	G1/4	8,6	11,5	2,2	0,20
3615-06	G3/8	10,6	14,9	2,2	0,40

3800

## Accessories

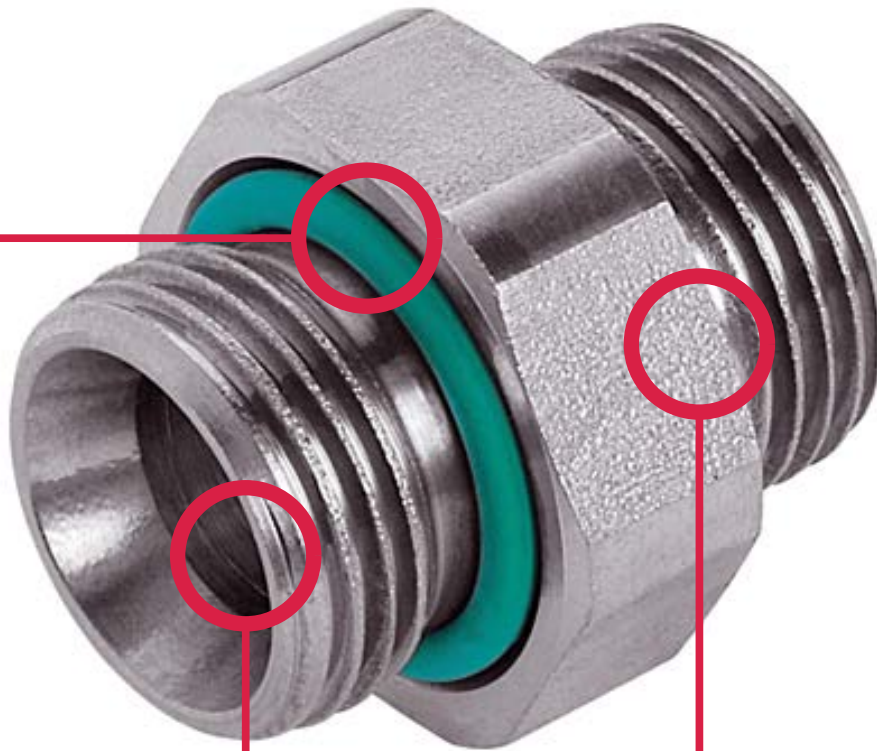

### All metal body

- Stainless steel, suitable for almost all media
- High-quality seals made of FPM; optional NBR, EPDM or other materials

### High flexibility due to many types

- Reductions
- Closure screw
- Removable double nipple
- Lots of standardized connection solutions

### Proved quality

- Cylindric thread as a standard
- All types of threads are possible
- Customized connection solutions on request

ACC

The ideal supplement for the Eisele INOXLINE connectors.

## Screw-in tube spigot

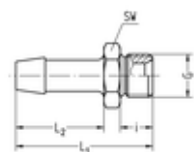

- Whitworth pipe thread
- Chambered O-rings FPM
- Material stainless steel AISI 304/304L (1.4301/1.4307)
- Temperature range -4 to 248 °F (-20 to +120 °C)
- Working pressure range -14 to 232 psi (-0.95 to 16 bar)

Part no.	G	for tube inside Ø	SW	i	L1	L2	NW	g/piece
1144-0812	G1/2	12	24	9,5	55,5	36	9,5	64
1144-0819	G1/2	19	24	9,5	55,5	36	14,5	76

## Double nipple

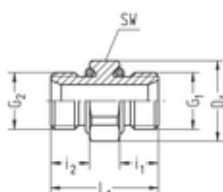

- Whitworth pipe thread, thread M5
- With inner cone according to DIN EN 560
- Chambered O-rings FPM
- Material stainless steel AISI 304/304L (1.4301/1.4307)
- Temperature range -4 to 248 °F (-20 to +120 °C)
- Working pressure range -14 to 232 psi (-0.95 to 16 bar)

Part no.	G1	G2	SW	D1	i1	i2	L1	NW	g/piece
1141-5050	M5	M5	8	-	4,5	4,5	13,5	2,5	2
1142-0202	G1/8	G1/8	13	14,2	7	7	20	5,5	9
1142-0404	G1/4	G1/4	17	18,5	9	9	25	7,5	20
1142-0606	G3/8	G3/8	22	23,8	9	9	26	10	34
1142-0808	G1/2	G1/2	24	26,2	11	11	30,5	12,5	53
1142-1010	G3/4	G3/4	32	34,8	12	12	37	18	102
1142-1212	G1	G1	41	44,7	14	14	43	22	193
1143-0250	G1/8	M5	13	14,2	7	4,5	17,5	2,5	8
1143-0402	G1/4	G1/8	17	18,5	9	7	23	5,5	19
1143-0604	G3/8	G1/4	22	23,8	9	9	26	7,5	33
1143-0806	G1/2	G3/8	24	26,2	11	9	28,5	10	48
1143-1210	G1	G3/4	41	44,7	14	12	40	18	167

ACC

## Thread adapter

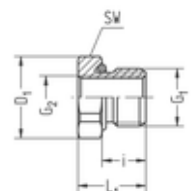

- Whitworth pipe thread, thread M5
- Chambered O-ring FPM
- Material stainless steel AISI 304/304L (1.4301/1.4307)
- Temperature range -4 to 248 °F (-20 to +120 °C)
- Working pressure range -14 to 232 psi (-0.95 to 16 bar)

Part no.	G1	G2	SW	D1	i	L1	g/piece
1170-0249	G1/8	M5	13	14,2	7	11	7
1170-0401	G1/4	G1/8	17	18,5	9	13,5	10
1170-0449	G1/4	M5	17	18,5	9	13,5	15
1170-0601	G3/8	G1/8	22	23,8	9	14,5	24
1170-0603	G3/8	G1/4	22	23,8	9	14,5	19
1170-0803	G1/2	G1/4	24	26,2	11	17	35
1170-0805	G1/2	G3/8	24	26,2	11	17	25



## Sleeve

- Whitworth pipe thread, thread M5
- Material stainless steel AISI 304/304L (1.4301/1.4307)
- Temperature range -4 to 248 °F (-20 to +120 °C)
- Working pressure range -14 to 232 psi (-0.95 to 16 bar)

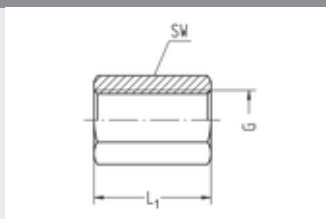

Part no.	G	SW	L1	g/piece
1159-0100	G1/8	14	17	15
1159-0300	G1/4	17	21	24
1159-0500	G3/8	22	21	39
1159-0700	G1/2	27	25	65
1159-0900	G3/4	32	28	106
1159-1100	G1	41	33	203
1160-4900	M5	8	9,5	3

## Closure screw

- Whitworth pipe thread, thread M5
- With hexagon socket
- Chambered O-ring FPM
- Material stainless steel AISI 304/304L (1.4301/1.4307)
- Temperature range -4 to 248 °F (-20 to +120 °C)
- Working pressure range -14 to 232 psi (-0.95 to 16 bar)

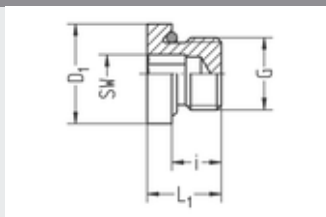

Part no.	G	SW	i	L1	D1	g/piece
1123-0200	G1/8	5	7	11	14	7
1123-0400	G1/4	6	9	13,5	18	14
1123-0600	G3/8	8	9	14	22	22
1123-0800	G1/2	10	11	16	26	38
1123-1000	G3/4	10	12	18	32	74
1124-5000	M5	2,5	4,5	7	8	1

## Double nipple removable

- Constant distance dimension
- Whitworth pipe thread
- Chambered O-rings
- Sealing FPM
- Material stainless steel AISI 304/304L (1.4301/1.4307)
- Temperature range -4 to 248 °F (-20 to +120 °C)
- Working pressure range -14 to 232 psi (-0.95 to 16 bar)

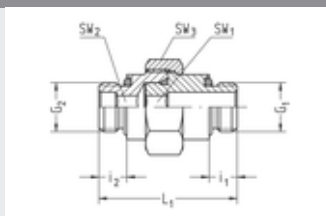

Part no.	G1	G2	SW1	SW2	SW3	i1	i2	L1	NW	M max. (Ncm)	g/piece
1176-0202	G1/8	G1/8	5	5	19	5,5	5,5	30	5	700	31
1176-0404	G1/4	G1/4	8	8	22	7,5	7,5	37	8,5	1500	55
1176-0606	G3/8	G3/8	10	10	27	7,5	7,5	39,5	10,2	2200	95
1176-0808	G1/2	G1/2	12	12	30	9,5	9,5	46	12,5	4000	117
1176-1010	G3/4	G3/4	14	14	41	10,5	10,5	56	15,5	6000	382
1176-1212	G1	G1	19	19	50	12,5	12,5	56	20	8000	530

ACC

## Non-return valve male thread, female thread

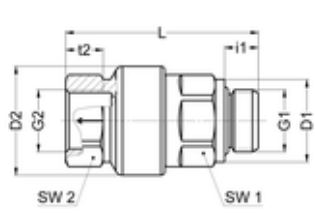

- Input: Whitworth pipe thread exterior
- Output: Whitworth pipe thread interior
- Sealing FPM
- Material AISI 316L (1.4404 )
- Type: Poppet valve, FPM seals on metal
- Allowable medium: Air/ Liquids
- Temperature range -4 to 248 °F (-20 to +120 °C)
- Working pressure range 7 to 232 psi (0.5 to 16 bar)

Part no.	G1	G2	Nominal flow-rate NI/min	SW1	SW2	L	D1	D2	i1	t2	NW	g/piece
3143-020104	G1/8	G1/8	770	14	14	35	14	15,2	6,5	8	4,5	31
3143-040306	G1/4	G1/4	1200	17	17	40	/	19	9	10	6	45
3143-040308	G1/4	G1/4	2000	18	17	44,5	17	23	9	10	8	67
3143-060510	G3/8	G3/8	3800	22	22	51,5	22	29	9	10	10	119
3143-080712	G1/2	G1/2	4200	27	27	54	30	30	11	12,5	12	150
3143-080716	G1/2	G1/2	5800	30	27	59,5	26	33	11	14	16	181
3143-100920	G3/4	G3/4	8900	32	32	66,5	32	39	14	16	20	252

## Non-return valve female thread, male thread

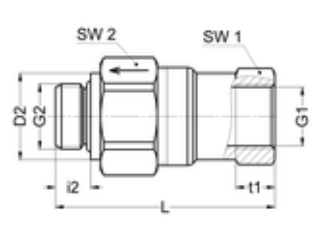

- Input: Whitworth pipe thread interior
- Output: Whitworth pipe thread exterior
- Sealing FPM
- Material AISI 316L (1.4404 )
- Type: Poppet valve, FPM seals on metal
- Allowable medium: Air/ Liquids
- Temperature range -4 to 248 °F (-20 to +120 °C)
- Working pressure range 7 to 232 psi (0.5 to 16 bar)

Part no.	G1	G2	Nominal flow-rate NI/min	SW1	SW2	L	D2	i2	t1	NW	g/piece
3145-010204	G1/8	G1/8	770	14	14	36	14	6,5	8	4,5	28
3145-030406	G1/4	G1/4	1200	17	17	42,5	-	9	10	6	44
3145-030408	G1/4	G1/4	2000	17	22	47,5	17	9	10	8	68
3145-050610	G3/8	G3/8	3800	22	27	56	22	9	10	10	130
3145-070812	G1/2	G1/2	4200	27	27	62	26	11	14	12	162
3145-070816	G1/2	G1/2	5800	30	32	65	26	11	14	16	189
3145-091020	G3/4	G3/4	8900	32	41	72,5	32	14	16	20	309

ACC

## Non-return valve male thread, male thread

- Input: Whitworth pipe thread exterior
- Output: Whitworth pipe thread exterior
- Sealing FPM
- Material AISI 316L (1.4404)
- Type: Poppet valve, FPM seals on metal
- Allowable medium: Air/ Liquids
- Temperature range -4 to 248 °F (-20 to +120 °C)
- Working pressure range 7 to 232 psi (0.5 to 16 bar)

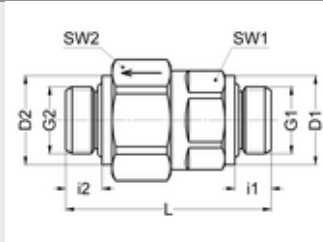

Part no.	G1	G2	Nominal flow-rate NI/min	SW1	SW2	L	D1	D2	i1	i2	NW	g/piece
3147-020204	G1/8	G1/8	770	14	14	32,5	14	14	6,5	6,5	4,5	24
3147-040406	G1/4	G1/4	1200	17	17	38	-	-	9	9	6	38
3147-040408	G1/4	G1/4	2000	18	22	44	17	17	9	9	8	110
3147-060610	G3/8	G3/8	3800	22	27	51	22	22	9	9	10	109
3147-080812	G1/2	G1/2	4200	27	27	54	26	26	11	11	12	140
3147-080816	G1/2	G1/2	5800	30	32	56,5	26	26	11	11	16	147
3147-101020	G3/4	G3/4	8900	32	41	65	32	32	14	14	20	256

## Non-return valve female thread, female thread

- Input: Whitworth pipe thread interior
- Output: Whitworth pipe thread interior
- Sealing FPM
- Material AISI 316L (1.4404)
- Type: Poppet valve, FPM seals on metal
- Allowable medium: Air/ Liquids
- Temperature range -4 to 248 °F (-20 to +120 °C)
- Working pressure range 7 to 232 psi (0.5 to 16 bar)

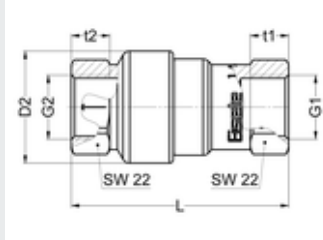

Part no.	G1	G2	Nominal flow-rate NI/min	SW1	SW2	L	D2	t1	t2	NW	g/piece
3148-010104	G1/8	G1/8	770	14	14	38,5	15,8	8	8	4,5	35
3148-030306	G1/4	G1/4	1200	17	17	44,5	-	10	10	6	52
3148-030308	G1/4	G1/4	2000	17	17	48	23	10	10	8	76
3148-050510	G3/8	G3/8	3800	22	22	56,5	29	10	10	10	140
3148-070712	G1/2	G1/2	4200	27	27	63	30	14	14	12	174
3148-070716	G1/2	G1/2	5800	27	27	68	33	14	14	16	223
3148-090920	G3/4	G3/4	8900	32	32	74	39	16	16	20	306

## Quick-release coupling with male thread

- Whitworth pipe thread
- Sealing FPM
- Material AISI 316L (1.4404)
- Allowable medium: air
- Temperature range -4 to 248 °F (-20 to +120 °C)
- Working pressure range 7 to 145 psi (0,5 to 10 bar)

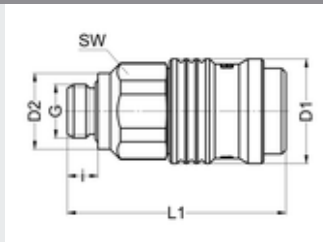

Part no.	G	SW	i	L1	D1	D2	NW	g/piece
4092-0407	G1/4	22	7,5	53,5	25,5	18,5	7	113g

ACC

## Plug nipple with male thread

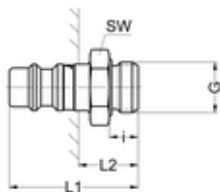

- Whitworth pipe thread
- Sealing FPM
- Material AISI 316L (1.4404)
- Temperature range -4 to 248 °F (-20 to +120 °C)
- Working pressure range 7 to 145 psi (0,5 to 10 bar)
- Fits to quick-release coupling

Part no.	G	for quick-release coupling NW	SW	i	L1	L2	g/piece
4095-0407	G1/4	7	17	7,5	33,5	15,5	21g

## Quick-release coupling with male thread for shutoff on both sides

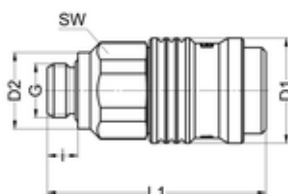

- Version with shut-off on both sides
- Whitworth pipe thread
- Sealing FPM
- Material AISI 316L (1.4404)
- Allowable medium: air
- Temperature range -4 to 248 °F (-20 to +120 °C)
- Working pressure range 7 to 145 psi (0,5 to 10 bar)

Part no.	G	SW	i	L1	D1	D2	NW	g/piece
4192-0407	G1/4	22	7,5	53,5	25,5	18,5	7	114g

## Plug nipple with male thread for shutoff on both sides

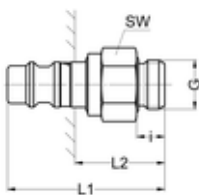

- Version with shut-off on both sides
- Whitworth pipe thread
- Material AISI 316L (1.4404)
- Temperature range -4 to 248 °F (-20 to +120 °C)
- Working pressure range 7 to 145 psi (0,5 to 10 bar)
- Fits to quick-release coupling

Part no.	G	for quick-release coupling NW	SW	i	L1	L2	g/piece
4195-0407	G1/4	7	17	7,5	42	24	30g

ACC

## Distributor, 2 inlets, 1-side

- Whitworth pipe thread, metric thread
- With 3/4/6 outlets
- Material 1.4301/ 1.4307
- Temperature range -4 to 248 °F (-20 to +120 °C)
- Working pressure -14 to 232 psi (-0,95 to 16 bar)

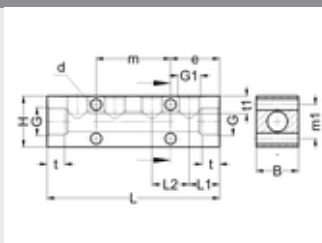

Part no.	G	G1	B	H	L	L1	L2	d	t	t1	e	m	m1	g/piece
1917-040149	G1/8	4x M5	16	16	62	13	12	2x 4,3	8,5	5	20	22	-	101
1917-030301	G1/4	3x G1/8	20	25	76	16	22	4x 6,5	10	8,5	27	22	17	218
1917-030503	G3/8	3x G1/4	25	30	80	18	22	4x 6,5	10	10	29	22	20	333
1917-040503	G3/8	4x G1/4	25	30	102	18	22	4x 6,5	10	10	29	44	20	437
1917-060503	G3/8	6x G1/4	25	30	146	18	22	4x 6,5	10	10	51	44	20	636
1917-030705	G1/2	3x G3/8	35	35	104	26	26	4x 6,5	12	10	39	26	25	739
1917-040705	G1/2	4x G3/8	35	35	130	26	26	4x 6,5	12	10	39	52	25	938
1917-060705	G1/2	6x G3/8	35	35	182	26	26	4x 6,5	12	10	65	52	25	1336

## Distributor block

- Whitworth pipe thread
- Material 1.4305
- Temperature range -20 to +120 °C
- Working pressure range -0.95 to 16 bar

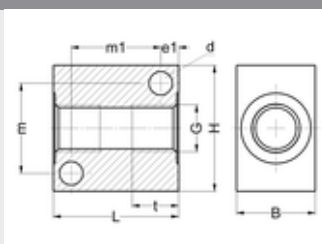

Part no.	G	B	H	D1	D2	t1	t2	e	m	g/piece
SA1675-03	G1/4	22	35	19,5	5,5	0,5	12,5	5	25	167

ACC

## VS seal ring

- For whitworth pipe thread, metric threads
- Sealing material FPM, FDA compliant according to 21 CFR 177.2600
- Spacer ring AISI 316L (1.4404)
- Large torque possible
- Undetachable
- Temperature range -4 to 248 °F (-20 to +120 °C)
- Working pressure range -14 to 435 psi (-0.95 to 30 bar)

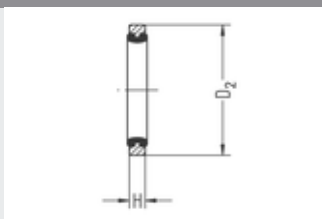

Part no.	for thread	D2	H	g/piece
915-0122	G1/8 and M10x1	14,7	2,2	1
915-0322	G1/4	17,7	2,2	1
915-0522	G3/8	21,8	2,2	1,56
915-0722	G1/2	26,3	2,2	2,04

## Seal ring

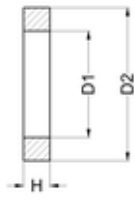

- For Whitworth pipe thread
- Material PTFE
- Temperature range 32 to 176 °F (0 to +80 °C)
- Working pressure range 0 to 362 psi (0 to 25 bar)

Part no.	for thread	D1	D2	H	g/piece
1615-04	G1/4	6,6	11,5	2,2	0,20
3615-02	G1/8	5,5	8,5	2,2	0,10
3615-04	G1/4	8,6	11,5	2,2	0,20
3615-06	G3/8	10,6	14,9	2,2	0,40

## Color coding



- Material aluminum anodized
- Fits all Eisele plug connectors

Part no.	for tube	Color	g/piece
SA1394-1102	OD4	red	1
SA1394-1104	OD6	red	1
SA1394-1106	OD8	red	1
SA1394-1108	OD10	red	1
SA1394-1109	OD12	red	1
SA1394-1111	OD14	red	1
SA1394-1112	OD16	red	1
SA1394-1202	OD4	green	1
SA1394-1204	OD6	green	1
SA1394-1206	OD8	green	1
SA1394-1208	OD10	green	1
SA1394-1209	OD12	green	1
SA1394-1211	OD14	green	1
SA1394-1212	OD16	green	1
SA1394-1302	OD4	blue	1
SA1394-1304	OD6	blue	1
SA1394-1306	OD8	blue	1
SA1394-1308	OD10	blue	1
SA1394-1309	OD12	blue	1
SA1394-1311	OD14	blue	1
SA1394-1312	OD16	blue	1

ACC

## Mounting bracket for Series 1800 and 1811

- Fits perfectly to the Eisele Multiple couplings
- D1 fits to the thread of the counter nut of the body
- Material: AISI 304 (1.4301)



Part no.	for thread	D1	G	L1	L2	L3	L4	L5	L6	D2	g/piece
1811-9523	M23x1	23	M6	45	30,5	33	21	29	17	6,5	37
1811-9530	M30x1	30	M6	53	35	33	21	38	26	6,5	52
1811-9536	M36x1	36	M6	59	37	33	21	44	32	6,5	61
1811-9538	M38x1	38	M6	65	42	33	21	46	34	6,5	65
1811-9540	M40x1	40	M6	67	43	33	21	48	36	6,5	72
1811-9542	M42x1	42	M6	69	44	33	21	50	38	6,5	72
1811-9546	M46x1	46	M6	70	43	33	21	54	42	6,5	76
1811-9548	M48x1	48	M6	71	43	33	21	56	44	6,5	79
1811-9550	M50x1	50	M6	75	45	33	21	58	46	6,5	84
1811-9552	M52x1	52	-	80	49	33	21	61	49	6,5	93
1811-9554	M54x1	54	M6	83	51	33	21	64	52	6,5	101
1811-9560	M60x1	60	-	88	52	33	21	71	59	6,5	111
1811-9564	M64x1	64	-	93	55	33	21	75	63	6,5	121
1811-9580	M80x1	80	-	113	67	33	21	91	79	6,5	159





## Customized connection solutions



Manifold suit to the clients requirements

### We master your individual specifications

- Combination of the different connection and screw joint series
- Individual types, e.g. extensions, arches
- Special threaded connections, e.g. female thread, fine thread, NPT
- Adaption of other systems, e.g. pipe screw joints, copper profiles, fabric lining tube
- Other sealing materials available, e.g. NBR, EPDM, FFKM
- Integrated valve technology, e.g. flow control, barriers, pressure reading
- Color coding
- Pre-assembled structural components
- Multiple couplings

CLIENT

## Quick exhaust valve

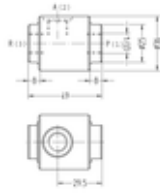

- Whitworth pipe thread
- Sealing NBR (Perbunan)
- Material 1.4305
- Type: Poppet valve
- Allowable medium: Air
- Temperature range -10 to +60 °C
- Working pressure range 0.5 to 10 bar

Part no.	G	Nominal flow-rate NI / min 1 => 2	Nominal flow-rate NI / min 2 => 3	NW	g/piece
SA1703-0304	G1/4	550	1400	6	81

## Shuttle valve

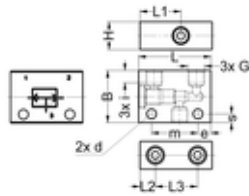

- Whitworth pipe thread
- Sealing NBR (Perbunan), PU
- Material AISI 303,304 (1.4305, 1.4301)
- Allowable medium: Air
- Temperature range 14 to 176 °F (-10 to +80 °C)
- Working pressure range 58 to 145 psi (4 to 10 bar)

Part no.	G	i	L	L1	L2	L3	B	H	d	e	m	s	NW	g/piece
SA1711-0100	G1/8	7	42	24	9	24,5	30	16	5,5	7,5	24	5	4	128

## Bulkhead connector O-Ring sealing

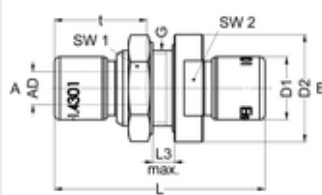

- Seals FPM
- Material AISI 304/ 304L (1.4301 / 1.4307)
- Temperature range -4 to 248 °F (-20 to +120 °C)
- Working pressure range -14 to 348 psi (-0.95 to 24 bar)

Part no.	G	for tube	SW1	SW2	L	L3 max.	D1	D2	t	NW	g/piece
SA1741-0404	M14x1	OD6	17	17	39	5	11,6	19,8	17,1	4	32
SA1741-0606	M16x1	OD8	19	19	45	5	14,8	21,8	20,3	6	45
SA1741-0808	M18x1	OD10	22	22	51	5	16,8	24,8	23,4	8	63

CLIENT

## Plastic tubes

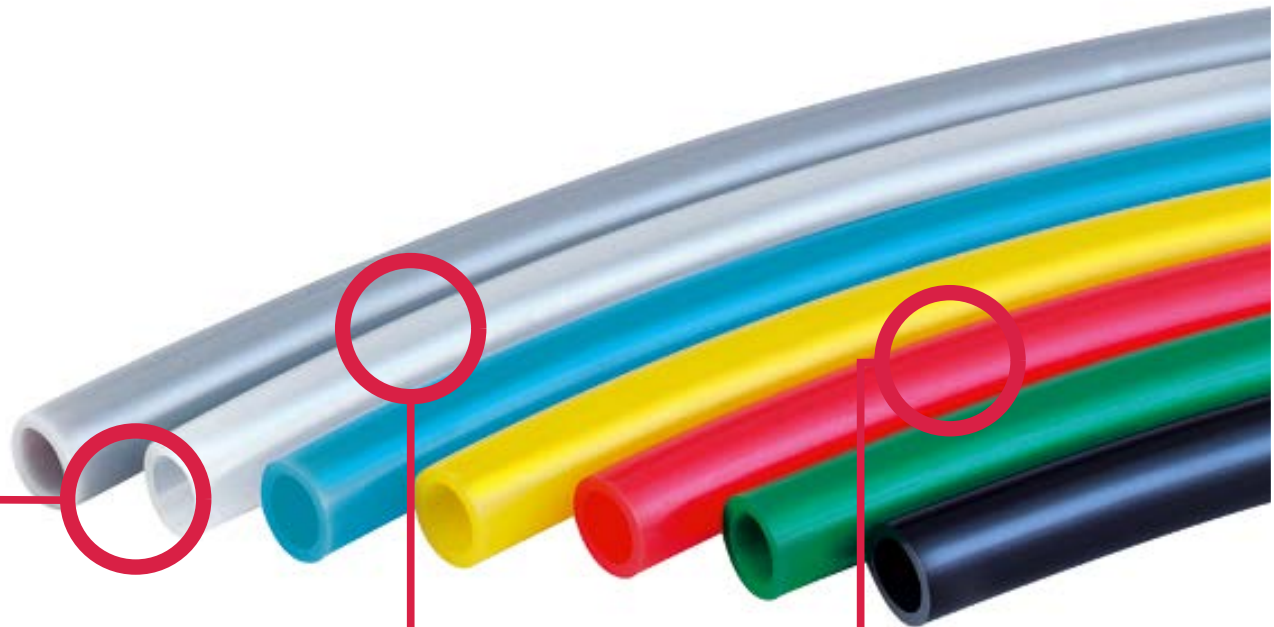

### Versatile range of tubes

- Standard compressed-air tubes as well as tubes for special applications and appropriate accessories
- Different tube materials for different application areas

### Color and code versions possible

- Tubes can be delivered in many common colors, e.g. to indicate different fluids
- Labeling of tubes for coding is also possible

### Package solutions of connectors and tubes

- Secure combinations of EISELE connectors and their matching tubes
- Very suitable for applications due to limited tolerances and a high demand for no leakage

On request we also offer tube solutions in other colors, sizes and materials.

## Tube types

Kind of calibration:

- Tubes for push-in fittings - external calibration, OD produced with narrow tolerances. Typical structure: single-layered, not reinforced with fabric lining.
- Tubes for spigots – internal calibration. Partly reinforced.

Kind of flexibility:

- Furthermore, a distinction is made between tubes which are resistant and nonresistant to buckling. Polyurethane tubes (e.g. PU, HYDRO Eisele, Eisele ProWeld) or PVC tubes are permanently flexible and relatively impervious to buckling! All other tubes have a clearly visible deformation (e.g. whitening) after buckling; replacement should be done.

## Resistance

Type of tube	Damage by weak acids/bases or water	Stress crack by polar solvents	Microbial/fungal damage	Physical radiation damage
Polyurethane (PU)	-	0	-	+*
Eisele Hydro/ProWeld	+	0	++	+
Polyamide (PA)	0/+	+	+	0
PFA	++	++	++	(UV) +

++	Excluded damage
+	Damage rarely
0	Damage occasionally
-	Damage often

\*PU bilged stronger than Eisele Hydro

## Temperatures

### Temperature - Material

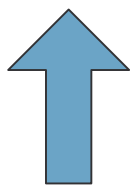

302 °F (150°C)	- PFA, PTFE (Teflon) at zero pressure up to 500 °F (260°C)
248 °F (120°C)	- FEP
212 °F (100°C)	- PA
194 °F (90°C)	- PU-Ether-based (Eisele ProWeld)
158 °F (70°C)	- PU-Ester-based (PU), NBR
140 °F (60°C)	- PE, PVC, PU-Ether-based (Eisele Hydro)
104 °F (40°C)	- PE

## Working pressure

The operating pressure is obtained by dividing the burst pressure by a safety factor. Safety factors are 2 to 4 (in pneumatics: typically 2.5 to 3)

Example:

- 435 psi (30 bar) burst pressure at 20 ° C results in an operating pressure of
- 145 psi (10 bar) with a safety factor of 3,
- 217 psi (15 bar) with a safety factor of 2

Eisele usually provides the burst pressure. Every customer can choose their own safety factor.

## Plastic tube PTFE

- Made of polytetrafluoroethylene (PTFE, Teflon)
- Color natural
- External calibration; for use with Eisele plug connectors
- Temperature range -310 to 500 °F (-190 to +260 °C)
- Operating pressure = burst pressure: safety (common factor 2 to 3)
- Free of plasticizers, PWIS and copper
- Resistant to UV and solvents
- FDA compliant according to 21 CFR 177.2600
- Flame-retardant according to UL94 V0 to V2

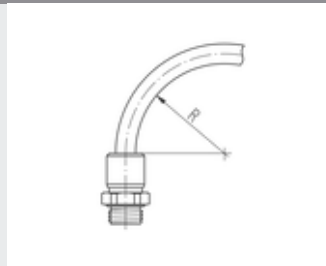

Part no.	Outside Ø / Inside Ø	Minimum burst pressure		min. allowable bend radius	g/m
		at 68°F (20°C)	at 122°F (50°C)		
99001-0335	3 / 0,35	290 psi (20 bar)	250 psi (17,5 bar)	35	-
99001-0305	3 / 0,5	-	-	-	-
99001-0307	3 / 0,7	-	-	-	-
99001-0310	3 / 1	-	-	-	-
99001-0315	3 / 1,5	217 psi (15 bar)	188 psi (13 bar)	25	-
99001-0402	4 / 2	1160 psi (80 bar)	1000 psi (69 bar)	16	20
99001-4303	4,3 / 3	522 psi (36 bar)	449 psi (31 bar)	35	16
99001-0503	5 / 3	870 psi (60 bar)	754 psi (52 bar)	25	27
99001-0604	6 / 4	696 psi (48 bar)	594 psi (41 bar)	35	34
99001-0805	8 / 5	812 psi (56 bar)	696 psi (48 bar)	-	-
99001-0806	8 / 6	522 psi (36 bar)	449 psi (31 bar)	65	47
99001-0906	9 / 6	696 psi (48 bar)	594 psi (41 bar)	55	76
99001-1008	10 / 8	406 psi (28 bar)	348 psi (24 bar)	100	61
99001-1209	12 / 9	580 psi (40 bar)	493 psi (34 bar)	100	106
99001-1210	12 / 10	304 psi (21 bar)	261 psi (18 bar)	100	-
99001-1411	14 / 11	406 psi (28 bar)	348 psi (24 bar)	140	127
99001-1613	16 / 13	348 psi (24 bar)	304 psi (21 bar)	175	152

## Plastic tube FEP

- Made of fluorinated ethylene-propylene copolymer (FEP)
- Color natural, transparent
- External calibration; for use with Eisele plug connectors
- Temperature range -31 to 248 °F (-35 to +120 °C)
- Operating pressure = burst pressure: Safety (common factor 2 to 3)
- Very flexible
- Free of plasticizer and copper
- Flame-retardant according to UL94 V0 to V2
- Resistant to UV, hydrolysis and microbes
- Stabilized against thermal degradation and light
- FDA compliant according to 21 CFR 177.2600
- Suitable for vacuum

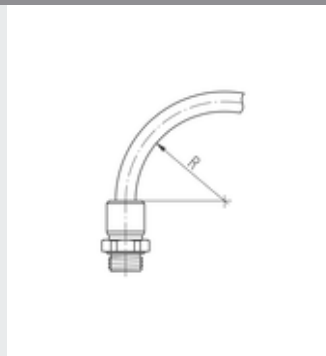

Part no.	Outside Ø / Inside Ø	Minimum burst pressure		min. allowable bend radius	g/m
		at 68°F (20°C)	at 140°F (60°C)		
99501-0402	4 / 2	1218 psi (84 bar)	1015 psi (70 bar)	25	21
99501-0503	5 / 3	870 psi (60 bar)	754 psi (52 bar)	35	28
99501-0604	6 / 4	725 psi (50 bar)	580 psi (40 bar)	40	35
99501-0806	8 / 6	522 psi (36 bar)	420 psi (29 bar)	65	49
99501-0906	9 / 6	-	-	55	79
99501-1008	10 / 8	406 psi (28 bar)	319 psi (22 bar)	100	63
99501-1209	12 / 9	-	-	100	110

## Plastic tube PFA

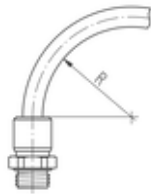

- Made of Perfluoro Alkoxyalkane (PFA)
- Color natural
- External calibration; for use with Eisele plug connectors
- Temperature range -4 to 302 °F (-20 to +150 °C)
- Operating pressure = burst pressure: Safety (common factor 2 to 3)
- Free of plasticizer and PWIS
- Resistant to UV, hydrolysis, microbes and solvents
- Stable against thermal degradation
- Resistant to weld spatter
- FDA compliant according to 21 CFR 177.2600
- Suitable for vacuum

Part no.	Outside Ø / Inside Ø	Minimum burst pressure at 68°F (20°C)	Minimum burst pressure at 140°F (60°C)	min. allowable bend radius	g/m
99221-0425	4 / 2,5	884 psi (61 bar)	725 psi (50 bar)	25	12
99221-0403	4 / 3	464 psi (32 bar)	493 psi (34 bar)	35	12
99221-0604	6 / 4	783 psi (54 bar)	638 psi (44 bar)	40	34
99221-0806	8 / 6	464 psi (32 bar)	493 psi (34 bar)	70	49
99221-0906	9 / 6	783 psi (54 bar)	638 psi (44 bar)	65	49
99221-1007	10 / 7	710 psi (49 bar)	580 psi (40 bar)	75	87
99221-1209	12 / 9	464 psi (32 bar)	493 psi (34 bar)	100	125
99221-1210	12 / 10	391 psi (27bar)	319 psi (22 bar)	150	-
99221-1412	14 / 12	333 psi (23 bar)	246 psi (17 bar)	-	-
99221-1614	16 / 14	290 psi (20 bar)	217 psi (15 bar)	-	-

## Plastic tube PE

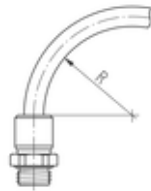

- Made of polyethylene (PE)
- Color black (red, blue, green, yellow, natural, brown, orange and grey: specify when placing order; subject to extra charge)
- External calibration; for use with Eisele plug connectors
- Temperature range 14 to 104°F (-10 to +40 °C)
- Free of plasticizer and halogen

Part no.	Outside Ø / Inside Ø	Maximum allowable working pressure at 73°F (23°C) (reference value)	min. allowable bend radius	g/m
99004-0402	4 / 2	290 psi (20 bar)	20	9
99004-4303	4,3 / 3	188 psi (13 bar)	20	7
99004-0503	5 / 3	217 psi (15 bar)	25	12
99004-0604	6 / 4	188 psi (13 bar)	30	15
99004-0806	8 / 6	116 psi (8 bar)	40	20
99004-1008	10 / 8	87 psi (6 bar)	60	26
99004-1209	12 / 9	130 psi (9 bar)	60	46
99004-1210	12 / 10	72 psi (5 bar)	85	32
99004-1411	14 / 11	116 psi (8 bar)	90	54
99004-1512	15 / 12	101 psi (7 bar)	90	59
99004-1613	16 / 13	87 psi (6 bar)	90	63



## Plastic tube PA

- Made of polyamide (PA)
- Color black (red, blue, green, yellow, natural, brown, orange and grey: specify when placing order; subject to extra charge)
- External calibration; for use with Eisele plug connectors
- Temperature range -76 to 212 °F (-60 to +100 °C)
- Operating pressure = burst pressure: safety (common factor 2 to 3)
- Suitable for vacuum
- Free of PWIS and halogen
- Suitable for fuel
- For automotive industry according to DIN 73378
- Drag chain compliant

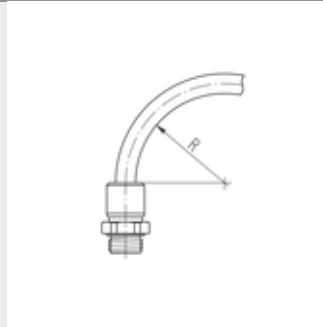

Part no.	Outside Ø / Inside Ø	Minimum burst pressure		min. allowable bend radius	g/m
		at 68°F (20°C)	at 140°F (60°C)		
99005-0402	4 / 2	2103 psi (145 bar)	1189 psi (82 bar)	20	10
99005-4303	4,3 / 3	1102 psi (76 bar)	623 psi (43 bar)	20	8
99005-0503	5 / 3	1624 psi (112 bar)	928 psi (64 bar)	25	13
99005-0604	6 / 4	1290 psi (89 bar)	739 psi (51 bar)	30	16
99005-0806	8 / 5	1348 psi (93 bar)	768 psi (53 bar)	40	32
99005-0906	9 / 6	1290 psi (89 bar)	739 psi (51 bar)	45	36
99005-1008	10 / 8	710 psi (49 bar)	406 psi (28 bar)	60	29
99005-1209	12 / 9	913 psi (63 bar)	521 psi (36 bar)	60	51
99005-1210	12 / 10	565 psi (39 bar)	319 psi (22 bar)	85	36
99005-1411	14 / 11	768 psi (53 bar)	435 psi (30 bar)	80	61
99005-1512	15 / 12	710 psi (49 bar)	406 psi (28 bar)	90	66
99005-1613	16 / 13	667 psi (46 bar)	377 psi (26 bar)	90	70
99005-1814	18 / 14	739 psi (51 bar)	420 psi (29 bar)	100	104
99005-2016	20 / 16	710 psi (49 bar)	406 psi (28 bar)	120	117

## Plastic tube PU

- Made of polyester-polyurethane (PU)
- Color black (red, blue, green, yellow, natural, brown, orange and grey: specify when placing order; subject to extra charge)
- External calibration; for use with Eisele plug connectors
- Temperature range -31 to 158 °F (-35 to +70 °C)
- Operating pressure = burst pressure: safety (common factor 2 to 3)
- Free of plasticizers, PWIS, copper and PTFE
- Impervious to buckling and drag chain compliant
- Suitable for vacuum

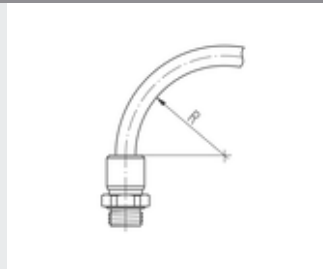

Part no.	Outside Ø / Inside Ø	Minimum burst pressure		min. allowable bend radius	g/m
		at 68°F (20°C)	at 140°F (60°C)		
99003-0402	4 / 2,3	652 psi (45 bar)	348 psi (24 bar)	10	12
99003-0425	4 / 2,5	565 psi (39 bar)	333 psi (23 bar)	13	12
99003-4303	4,3 / 2,9	522 psi (36 bar)	319 psi (22 bar)	14	12
99003-0503	5 / 3,1	652 psi (45 bar)	348 psi (24 bar)	12	16
99003-0604	6 / 3,9	522 psi (36 bar)	333 psi (23 bar)	20	22
99003-0806	8 / 5,7	464 psi (32 bar)	290 psi (20 bar)	35	31
99003-1008	10 / 7,5	406 psi (28 bar)	232 psi (16 bar)	50	40
99003-1208	12 / 8	609 psi (42 bar)	377 psi (26 bar)	50	78
99003-1209	12 / 9	420 psi (29 bar)	246 psi (17 bar)	55	62
99003-1410	14 / 10	478 psi (33 bar)	290 psi (20 bar)	70	80
99003-1411	14 / 11	333 psi (23 bar)	217 psi (15 bar)	70	75
99003-1611	16 / 11	464 psi (32 bar)	304 psi (21 bar)	70	132

## Plastic tube Eisele ProWeld

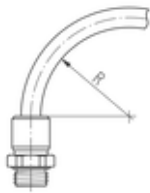

- Made of polyether-polyurethane
- Color black (red, blue, green, white)
- External calibration; for use with Eisele plug connectors
- Operating temperature -31 to 194 °F (-35 to +90 °C)
- Operating pressure = burst pressure: safety (common factor 3)
- Suitable for compressed air, water
- Free of plasticizers, PWIS, halogen, copper and PTFE
- Impervious to buckling and drag chain compliant
- Resistant to UV, hydrolysis and microbes
- Flame-retardant according to UL94 V0 to V2
- Suitable for employment in welding
- Suitable for vacuum

Part no.	Outside Ø / Inside Ø	Minimum burst pressure at 68°F (20°C)	Minimum burst pressure at 140°F (60°C)	min. allowable bend radius	g/m
99118-0302	3 / 2	652 psi (45 bar)	-	-	-
99118-0402	4 / 2	826 psi (57 bar)	580 psi (40 bar)	8	12
99118-4303	4,3/3	551 psi (38 bar)	232 psi (16 bar)	-	-
99118-0603	6 / 3	826 psi (57 bar)	580 psi (40 bar)	10	27,5
99118-0604	6 / 4	580 psi (40 bar)	319 psi (22 bar)	14	22
99118-0804	8 / 4	913 psi (63 bar)	536 psi (37 bar)	10	48
99118-0855	8 / 5,5	493 psi (34 bar)	260 psi (18 bar)	21	33
99118-1006	10 / 6	710 psi (49 bar)	406 psi (28 bar)	20	65
99118-1208	12 / 8	493 psi (34 bar)	304 psi (21 bar)	33	81
99118-1410	14 / 10	478 psi (33 bar)	260 psi (18 bar)	41	98
99118-1611	16 / 11	536 psi (37 bar)	275 psi (19 bar)	47	137
99118-2014	20 / 14	ca. 507 psi (35 bar)	ca. 232 psi (16 bar)	70	ca. 200

## Plastic tube Eisele Hydro

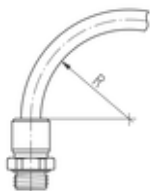

- Made of polyether-polyurethane (PU-H)
- Color imbued: black, blue, red
- External calibration; for use with Eisele plug connectors
- Temperature range -31 to 140 °F (-35 to +60 °C)
- Operating pressure = burst pressure: Safety (common factor 3)
- Free of halogen, plasticizers, PWIS, copper and PTFE
- Impervious to buckling and drag chain compliant
- Resistant to UV, hydrolysis and microbes
- FDA compliant according to 21 CFR 177.2600
- Suitable for vacuum

Part no.	Outside Ø / Inside Ø	Minimum burst pressure at 68°F (20°C)	Minimum burst pressure at 140°F (60°C)	min. allowable bend radius	g/m
99150-0425	4 / 2,5	478 psi (33 bar)	232 psi (16 bar)	8	9
99150-0604	6 / 4	464 psi (32 bar)	217 psi (15 bar)	10	18
99150-0806	8 / 6	391 psi (27bar)	188 psi (13 bar)	21	29
99150-1007	10 / 7	406 psi (28 bar)	188 psi (13 bar)	28	47
99150-1208	12 / 8	464 psi (32 bar)	232 psi (16 bar)	33	73
99150-1410	14 / 10	393 psi (27,1 bar)	190 psi (13,2 bar)	33	73
99150-1611	16 / 11	435 psi (30 bar)	203 psi (14 bar)	38	123
99150-2014	20 / 14	417 psi (28,8 bar)	203 psi (14 bar)	-	ca. 187

## Plastic tube Eisele Hydro, translucent

- Made of polyether-polyurethane (PU-H)
- Color transparent: natural, red, blue
- External calibration; for use with Eisele plug connectors
- Temperature range -31 to 140 °F (-35 to +60 °C)
- Operating pressure = burst pressure: Safety (common factor 2 to 3)
- Free of halogen, plasticizers, PWIS, copper and PTFE
- Impervious to buckling and drag chain compliant
- Resistant to hydrolysis and microbes
- FDA compliant according to 21 CFR 177.2600
- Suitable for vacuum



Part no.	Outside Ø / Inside Ø	Minimum burst pressure		min. allowable bend radius	g/m
		at 68°F (20°C)	at 140°F (60°C)		
99151-0425	4 / 2,5	478 psi (33 bar)	232 psi (16 bar)	8	9
99151-0604	6 / 4	464 psi (32 bar)	217 psi (15 bar)	10	18
99151-0806	8 / 6	391 psi (27bar)	188 psi (13 bar)	21	29
99151-1007	10 / 7	406 psi (28 bar)	188 psi (13 bar)	28	47
99151-1208	12 / 8	464 psi (32 bar)	232 psi (16 bar)	33	73
99151-1410	14 / 10	393 psi (27,1 bar)	190 psi (13,2 bar)	33	73
99151-1611	16 / 11	435 psi (30 bar)	203 psi (14 bar)	38	123
99151-2014	20 / 14	417 psi (28,8 bar)	203 psi (14 bar)	-	ca. 187

- For compressed-air tubes with outer-Ø 14 mm
- Material plastic black / steel
- Packaging unit 1 piece



Part no.		g/piece
99605-0014	Tube cutter for outer diameter up to 14	30
99605-00149	Spare blade for outer diameter up to 14	1

- For compressed-air tubes with outer-Ø 22 mm
- Material zinc die-casting / steel
- Packaging unit 1 piece



Part no.		g/piece
99606-0022	Tube cutter for outer diameter up to 22 (with bag)	240
99606-00229	Spare blade for outer diameter up to 22	2

Type designation	Page
<b>4</b>	
4-way connector .....	15
<b>B</b>	
Bulkhead connector .....	16,49
Bulkhead connector with O-Ring sealing .....	62
Bulkhead plug connector, tube/pipe .....	41
Bulkhead plug connector, tube/tube, two-piece .....	41
<b>C</b>	
Closure plug .....	18
Color coding .....	58
<b>D</b>	
Distributor block .....	57
Distributor, 2 inlets, 1-side .....	57
Double connector .....	14
Double nipple .....	52
Double nipple removable .....	53
Double plug .....	18
<b>E</b>	
Elbow bulkhead connector, swiveling .....	16
Elbow connector .....	14
Elbow plug .....	18
Elbow screw-in connector swiveling .....	11
Elbow screw-in connector, swiveling .....	11-12
Elbow-bulkhead plug connector, tube/pipe, two-piece .....	42
Elbow-bulkhead plug connector, tube/tube, two-piece .....	42
Elbow-screw-in plug connector 45°, lockable .....	40
Elbow-screw-in plug connector, lockable .....	39-40
Elbow-screw-in plugconnector, lockable .....	49
<b>L</b>	
L screw-in, pivoting .....	16
L-screw-in plug connector, lockable .....	40
<b>N</b>	
Non-return valve female thread, female thread .....	55
Non-return valve female thread, male thread .....	54
Non-return valve male thread, female thread .....	54
Non-return valve male thread, male thread .....	55
<b>O</b>	
Or-valve .....	62
<b>P</b>	
Plastic tube Eisele Hydro .....	68-69
Plastic tube Eisele ProWeld .....	68
Plastic tube FEP .....	65
Plastic tube PA .....	67
Plastic tube PE .....	66
Plastic tube PFA .....	66
Plastic tube PTFE .....	65
Plastic tube PU .....	67
Plug nipple with male thread .....	56
Plug nipple with male thread for shut-off on both sides .....	56
<b>Q</b>	
Quick exhaust valve .....	62
Quick-release coupling with male thread for shut-off on both sides .....	56
Quick-release coupling with male thread .....	55
<b>R</b>	

Type designation	Page
Reducing plug .....	17
<b>S</b>	
Screw plug .....	53
Screw-in connector.....	9-10,49
Screw-in plug connector .....	39
Screw-in tube spigot .....	52
Seal ring.....	50,58
Single banjo.....	31
Single swivel connector with throttle check valve.....	17
Single swivel connector, short model .....	13
Sleeve.....	53
Sleeve for hose marking .....	43
Straight male stud coupling .....	31
Straight screw-in connector with female thread .....	11
<b>T</b>	
T-connector.....	15
T-screw-in connector, swiveling .....	12
T-screw-in plug connector, lockable.....	40
Thread adapter .....	52
Tool case .....	43
Tube cutter .....	69
Tube sharpener .....	43
<b>V</b>	
VS seal ring.....	57
<b>Y</b>	
Y-connector.....	15
Y-screw-in plug connector, lockable .....	41

Article No.	Page	Article No.	Page	Article No.	Page	Article No.	Page
SA1394-1102	58	VT1729-4804	23	VT1787-5202	25	917-0308	11
SA1394-1104	58	VT1729-5002	23	VT1787-5204	25	917-0504	11
SA1394-1106	58	VT1729-5004	23	VT1787-5402	25	917-0506	11
SA1394-1108	58	VT1729-5202	23	VT1787-5404	25	917-0508	11
SA1394-1109	58	VT1729-5204	23	VT1787-5406	25	917-0704	11
SA1394-1111	58	VT1733-0808	26	VT1787-5406X	25	917-0706	11
SA1394-1112	58	VT1733-0909	26	VT4504-0202	30	917-0708	11
SA1394-1202	58	VT1733-0202	26	VT4504-0204	30	921-0204	17
SA1394-1204	58	VT1733-0606	26	VT4504-0206	30	921-0402	17
SA1394-1206	58	VT1733-0404	26	VT4504-0402	30	921-0604	17
SA1394-1208	58	VT1762-0202	24	VT4504-0404	30	921-0906	17
SA1394-1209	58	VT1762-0204	24	VT4504-0406	30	921-0908	17
SA1394-1211	58	VT1762-0206	24	VT4504-0408	30	921-0806	17
SA1394-1212	58	VT1762-0208	24	VT4504-0604	30	921-0804	17
SA1394-1302	58	VT1762-0402	24	VT4504-0606	30	921-0602	17
SA1394-1304	58	VT1762-0404	24	VT4504-0608	30	921-1209	17
SA1394-1306	58	VT1762-0406	24	VT4504-0609	30	923-0200	18
SA1394-1308	58	VT1762-0408	24	VT4504-0611	30	923-0400	18
SA1394-1309	58	VT1762-0409	24	VT4504-0808	30	923-0600	18
SA1394-1311	58	VT1762-0606	24	VT4504-0809	30	923-0800	18
SA1394-1312	58	VT1762-0608	24	VT4504-0811	30	923-0900	18
SA1675-03	57	VT1762-0609	24	VT4504-0812	30	923-1100	18
SA1699-0408	31	VT1763-4602	24	VT4504-0815	30	928-0202	9
SA1703-0304	62	VT1763-4802	24	VT4528-0202	30	928-0204	9
SA1711-0100	62	VT1763-4804	24	VT4528-0204	30	928-0206	9
SA1741-0404	62	VT1763-5002	24	VT4528-0206	30	928-0402	9
SA1741-0606	62	VT1763-5004	24	VT4528-0402	30	928-0404	9
SA1741-0808	62	VT1763-5202	24	VT4528-0404	30	928-0406	9
VT28-0204GSW4	31	VT1763-5204	24	VT4528-0406	30	928-0408	9
VT28-0208GSW4	31	VT1763-5402	24	VT4528-0408	30	928-0606	9
VT28-0604GSW4	31	VT1763-5404	24	VT4528-0409	30	928-0608	9
VT28-0608GSW4	31	VT1763-5406	24	VT4528-0606	30	928-0609	9
VT234-0408K934	17	VT1772-0404	27	VT4528-0608	30	928-0806	9
VT234-0402K934	17	VT1777-0200	26	VT4528-0609	30	928-0808	9
VT234-0204K934	17	VT1777-0400	26	VT4528-0611	30	928-0809	9
VT234-0206K934	17	VT1777-0600	26	VT4528-0808	30	928-0604	9
VT234-0404K934	17	VT1777-0800	26	VT4528-0809	30	928-0611	9
VT234-0202K934	17	VT1777-0900	26	VT4528-0811	30	928-0804	9
VT234-0406K934	17	VT1778-0200	27	VT4528-0812	30	928-0811	9
VT234-0208K934	17	VT1778-0400	27	VT4528-0815	30	928-0409	9
VT1702-0102	28	VT1778-0600	27	WZ660-03	43	928-0815	9
VT1704-0404	26	VT1778-0800	27	WZ660-04	43	928-1015	9
VT1704-0604	26	VT1778-0900	27	WZ660-05	43	928-0812	9
VT1717-0104	24	VT1786-0202	25	WZ660-06	43	928-0208	9
VT1721-0402	28	VT1786-0204	25	WZ660-0603	43	928-0204X	9
VT1721-0602	28	VT1786-0206	25	WZ660-09	43	929-4202	9
VT1721-0604	28	VT1786-0208	25	WZ660E	43	929-5002	9
VT1728-0202	23	VT1786-0209	25	WZ688-05	43	929-5004	9
VT1728-0204	23	VT1786-0402	25	WZ688-06	43	929-5006	9
VT1728-0206	23	VT1786-0404	25	WZ688-09	43	929-4604	9
VT1728-0208	23	VT1786-0406	25	WZ688-12	43	932-0204	14
VT1728-0402	23	VT1786-0408	25	4092-0407	55	932-0406	14
VT1728-0404	23	VT1786-0409	25	4095-0407	56	932-0408	14
VT1728-0406	23	VT1786-0604	25	4192-0407	56	932-0608	14
VT1728-0408	23	VT1786-0606	25	4195-0407	56	932-0609	14
VT1728-0409	23	VT1786-0608	25	68-0813W5	31	932-0809	14
VT1728-0604	23	VT1786-0609	25	68-1019W5	31	933-0202	14
VT1728-0606	23	VT1786-0804	25	914-0606	16	933-0404	14
VT1728-0608	23	VT1786-0806	25	915-0122	57	933-0606	14
VT1728-0609	23	VT1786-0808	25	915-0322	57	933-0808	14
VT1728-0804	23	VT1786-0809	25	915-0522	57	933-0909	14
VT1728-0806	23	VT1786-0812	25	915-0722	57	933-1818	14
VT1728-0808	23	VT1787-4602	25	917-0102	11	933-1212	14
VT1728-0809	23	VT1787-4802	25	917-0104	11	934-0202K	13
VT1728-0811	23	VT1787-4804	25	917-0106	11	934-0204K	13
VT1728-0812	23	VT1787-5002	25	917-0304	11	934-0206K	13
VT1729-4802	23	VT1787-5004	25	917-0306	11	934-0402K	13

Article No.	Page	Article No.	Page	Article No.	Page	Article No.	Page
934-0404K	13	986-0604	11	1170-0805	52	1663-040500	40
934-0406K	13	986-0604X	11	1176-0202	53	1680-000404	41
934-0408K	13	986-0606	11	1176-0404	53	1680-000406	41
934-0208K	13	986-0608	11	1176-0606	53	1680-000505	41
934-0409K	13	986-0609	11	1176-0808	53	1680-000606	41
935-5002K	13	986-0611	11	1176-1010	53	1680-000609	41
935-5004K	13	986-0612	11	1176-1212	53	1680-000909	41
941-0202	18	986-0806	11	1614-000606	42	1694-000404	41
962-0206	10	986-0808	11	1614-000609	42	1694-000607	41
962-0202	10	986-0809	11	1614-000906	42	1694-000609	41
962-0204	10	986-0811	11	1614-000909	42	1694-000907	41
962-0402	10	986-0812	11	1615-000607	42	1694-000909	41
962-0404	10	986-0815	11	1615-000609	42	1811-9523	59
962-0406	10	987-4202	12	1615-000907	42	1811-9530	59
962-0408	10	987-4604	12	1615-000909	42	1811-9536	59
962-0606	10	987-5002	12	1615-04	50,58	1811-9538	59
962-0608	10	987-5004	12	1616-000607	42	1811-9540	59
962-0609	10	988-0202	12	1616-000609	42	1811-9542	59
962-0604	10	988-0204	12	1616-000907	42	1811-9546	59
962-0804	10	988-0206	12	1616-000909	42	1811-9548	59
962-0806	10	988-0402	12	1619-020606	41	1811-9550	59
962-0808	10	988-0404	12	1619-020609	41	1811-9552	59
962-0809	10	988-0406	12	1619-020909	41	1811-9554	59
963-5002	10	988-0408	12	1619-040606	41	1811-9560	59
963-5004	10	988-0409	12	1619-040609	41	1811-9564	59
975-0606	15	988-0606	12	1619-040909	41	1811-9580	59
975-0404	15	988-0608	12	1619-060606	41	1917-030301	57
977-0200	14	988-0609	12	1619-060609	41	1917-030503	57
977-0400	14	988-0806	12	1619-060909	41	1917-030705	57
977-0600	14	988-0808	12	1628-020300	39	1917-040149	57
977-0800	14	988-0809	12	1628-020400	39	1917-040503	57
977-0900	14	989-4202	12	1628-020500	39	1917-040705	57
977-1100	14	989-5002	12	1628-020600	39	1917-060503	57
977-1200	14	989-5004	12	1628-020900	39	1917-060705	57
978-0200	15	1123-0200	53	1628-040300	39	3143-020104	54
978-0800	15	1123-0400	53	1628-040400	39	3143-040306	54
978-0900	15	1123-0600	53	1628-040500	39	3143-040308	54
978-0400	15	1123-0800	53	1628-040600	39	3143-060510	54
978-0600	15	1123-1000	53	1628-040900	39	3143-080712	54
978-0204	15	1124-5000	53	1628-060500	39	3143-080716	54
978-1100	15	1141-5050	52	1628-060600	39	3143-100920	54
978-1200	15	1142-0202	52	1628-060900	39	3145-010204	54
978-1800	15	1142-0404	52	1658-020606	40	3145-030406	54
979-0400	15	1142-0606	52	1658-020609	40	3145-030408	54
980-0202	16	1142-0808	52	1658-020909	40	3145-050610	54
980-0404	16	1142-1010	52	1658-040606	40	3145-070812	54
980-0606	16	1142-1212	52	1658-040609	40	3145-070816	54
980-0808	16	1143-0250	52	1658-040909	40	3145-091020	54
980-0909	16	1143-0402	52	1661-020400	39	3147-020204	55
980-1111	16	1143-0604	52	1661-020600	39	3147-040406	55
980-1212	16	1143-0806	52	1661-020900	39	3147-040408	55
980-1515	16	1143-1210	52	1661-040400	39	3147-060610	55
981-0204	16	1144-0812	52	1661-040500	39	3147-080812	55
981-0406	16	1144-0819	52	1661-040600	39	3147-080816	55
981-0608	16	1159-0100	53	1661-040900	39	3147-101020	55
981-0809	16	1159-0300	53	1661-060600	39	3148-010104	55
986-0202	11	1159-0500	53	1661-060900	39	3148-030306	55
986-0204	11	1159-0700	53	1662-020505	40	3148-030308	55
986-0204X	11	1159-0900	53	1662-020606	40	3148-050510	55
986-0206	11	1159-1100	53	1662-020609	40	3148-070712	55
986-0208	11	1160-4900	53	1662-020909	40	3148-070716	55
986-0209	11	1170-0249	52	1662-040606	40	3148-090920	55
986-0402	11	1170-0401	52	1662-040609	40	3828-040900	49
986-0404	11	1170-0449	52	1662-040909	40	3828-060900	49
986-0406	11	1170-0601	52	1663-020400	40	3828-020600	49
986-0408	11	1170-0603	52	1663-020600	40	3880-000909	49
986-0409	11	1170-0803	52	1663-020900	40	3880-000606	49



Article No.	Page	Article No.	Page
99001-0305	65	99221-0604	66
99001-0307	65	99221-0806	66
99001-0310	65	99221-0906	66
99001-0315	65	99221-1007	66
99001-0335	65	99221-1209	66
99001-0402	65	99221-1210	66
99001-0503	65	99221-1412	66
99001-0604	65	99221-1614	66
99001-0805	65	99501-0402	65
99001-0806	65	99501-0503	65
99001-0906	65	99501-0604	65
99001-1008	65	99501-0806	65
99001-1209	65	99501-0906	65
99001-1210	65	99501-1008	65
99001-1411	65	99501-1209	65
99001-1613	65	99605-0014	69
99001-4303	65	99605-00149	69
99003-1008	67	99606-0022	69
99003-1208	67	99606-00229	69
99003-1209	67		
99003-1410	67		
99003-1411	67		
99003-1611	67		
99003-4303	67		
99004-0402	66		
99004-0503	66		
99004-0604	66		
99004-0806	66		
99004-1008	66		
99004-1209	66		
99004-1210	66		
99004-1411	66		
99004-1512	66		
99004-1613	66		
99004-4303	66		
99005-0402	67		
99005-0503	67		
99005-0604	67		
99005-0806	67		
99005-0906	67		
99005-1008	67		
99005-1209	67		
99005-1210	67		
99005-1411	67		
99005-1512	67		
99005-1613	67		
99005-1814	67		
99005-2016	67		
99005-4303	67		
99150-0425	68		
99150-0604	68		
99150-0806	68		
99150-1007	68		
99150-1208	68		
99150-1410	68		
99150-1611	68		
99150-2014	68		
99151-0425	69		
99151-0604	69		
99151-0806	69		
99151-1007	69		
99151-1208	69		
99151-1410	69		
99151-1611	69		
99151-2014	69		
99221-0403	66		
99221-0425	66		



## MANY SOLUTIONS FROM ONE MODULAR SYSTEM:

### EISELE BASICLINE

#### Standard components for pneumatics

EISELE **BASICLINE** gives our customers a wide choice of our stock of approximately 5,000 standardized connection components. We can therefore deliver at very short notice a complete range of screw joints, plug connectors, matching tubes and a wide spectrum of accessories.

Many of these EISELE products are authorized for use by major automotive manufacturers like Audi, Daimler or Volkswagen.

### EISELE INOXLINE

#### Stainless steel connection solutions

Stainless steel connections are frequently called for systems in the food and pharmaceutical sectors – and they are essential for many applications.

Based on the design of our tried-and-tested standard components, we supply a broad range of media-resistant connections made of corrosion-proof and acid-resistant stainless steel. The connections are equally tough enough for aggressive production environments and cleaning products.



## FROM STANDARDIZED TO HIGHLY INDIVIDUAL

### EISELE LIQUIDLINE

#### Connections for cooling water

The through-flow-optimized connections in the EISELE **LIQUIDLINE** are perfectly suited for applications with closed cooling-water cycles.

All parts in contact with media are made of a brass alloy not susceptible to dezincification. When combined with the tubes, connections with FPM seals are resistant to many media as well as high temperatures.

### EISELE MULTILINE

#### Multiple couplings for multiple media connections

From plant installations, to maintenance and repair, the couplings in the EISELE **MULTILINE** join separate components or complete modules in a safe, efficient and space-saving way with the simple, centralized, plug and screw joint connectors. In machines with combined air and liquid inlets, the connections discourage assembly mistakes. They can also be coupled and uncoupled under pressure thanks to the integrated shut-off valves.





Flow optimised coolant connections

**LIQUIDLINE**

Around 4000 connection components for pneumatics and vacuum

**BASICLINE**



Connectors for use in applications with high hygienic requirements

**CLEANLINE**

Multiple couplings and multiple media connections for pneumatics, fluids and electronics

**MULTILINE**



**QUALITY CONNECTION COMPONENTS FOR COMPRESSED AIR, GASES, LIQUIDS, ELECTRICS AND ELECTRONICS**



Eisele Connectors Inc. | USA  
sales@eisele-connectors.com  
www.eisele-connectors.com  
Phone: +1 616-930-4563